



Standard-Programme – Drill Reamer

Drill-Reamer-Pyramid | Drill-Reamer

BECK
MAPAL GROUP

Drill-Reamer-Pyramid

The new drill reamer with pyramid tip – centering, drilling and reaming in one shot

In order to manufacture economically and reduce productive and non-productive times, it is a proven means to combine individual work steps.

For the complete machining of bores in steel or short-chipping materials such as cast iron, BECK presents the new drill reamer with pyra-

mid tip. It combines centering, solid drilling and reaming of the hole in only one shot. In addition to optimum self-centering, the pyramid tip also ensures that the drill reamer can penetrate the component without any problems. Due to the very small chisel edge at a tip angle of 140° , spot drilling is also successful in unstable con-

ditions. The optimally designed cutting edge for reaming produces best surfaces, a new coating enables long tool life.



The pyramid tip

- Improved material penetration during entry
- Optimum self-centering
- Centering, drilling and reaming with a single tool

AT A GLANCE

- Internal coolant supply
- Centering, drilling and reaming in one work step
- Reduction of productive and non-productive times
- Improved entry behavior during unstable machining situations
- TiAlN coating for longer tool life



Drill-Reamer-Pyramid

The drill reamer with pyramid tip –
centering, drilling and reaming in one shot

Drill-Reamer-Pyramid, 5xD - internal coolant supply _____ 4

Drill-Reamer

The drill reamer combines two operations
in one tool: drilling and reaming

With the drill reamers, drilling and reaming operations are performed in a single step. In this way, holes can be machined faster and more efficiently and the main and non-productive times can be significantly reduced. Two drill cutting edges of the coated tool initially carry out the full drilling operation. Four axially slightly offset reaming cutting edges then provide the finish machining and ensure the required surfaces, dimensional accuracy and roundness in reaming quality.

Drill-Reamer, 5xD – internal coolant supply _____ 6

Drill-Reamer, 3xD – internal coolant supply _____ 8

Drill-Reamer, 3xD – external coolant supply _____ 10

Cutting data

for Drill-Reamer-Pyramid | Drill-Reamer _____ 11

Drill-Reamer-Pyramid

Drill Reamer, Preferred series

B093505 (5xD), internal coolant supply, with pyramid tip

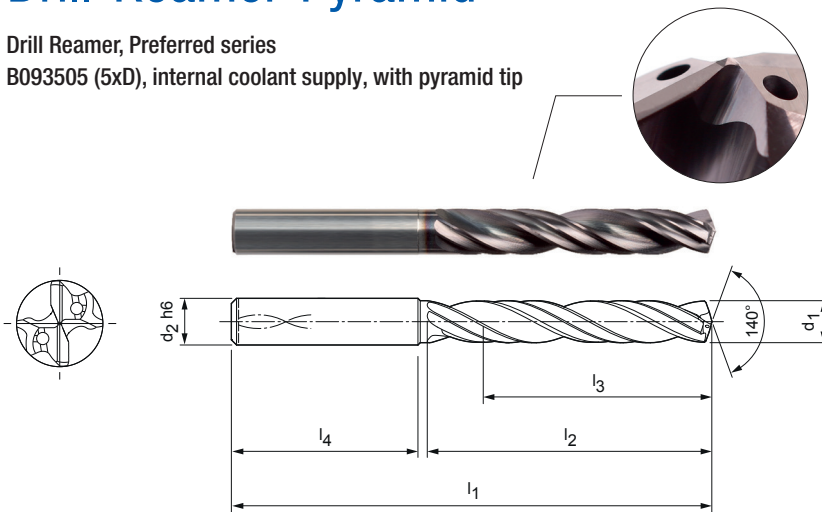

Design:

- Drill diameter: 3,970 - 16,050 mm
- Bore tolerance: ≥ IT 7
- Cutting material: Solid carbide, special TiAlN-Coating
- Number of cutting edges: 2
- Number of guiding chamfers: 4
- Point angle: 140°
- Helix angle: 30°
- Special features: With pyramid tip, inclined bore entry up to max. 10°.

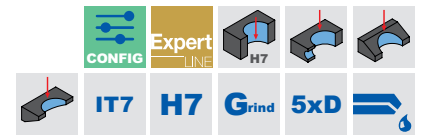

Preferred series in stock

Dimensions							Shank form HA	
d ₁	Tolerance	d ₂ h6	l ₁	l ₂	l ₃	l ₄	Specification	Order-No.
4,00	H7	6	74	36	29	36	B093505-4.000H7AR	31178666
5,00	H7	6	91	53	43	36	B093505-5.000H7AR	31178667
5,98	±0,003	6	91	53	43	36	B093505-5.980+3-3AR	31178565
6,00	±0,003	6	91	53	43	36	B093505-6.000+3-3AR	31178567
6,00	H7	6	91	53	43	36	B093505-6.000H7AR	31178668
6,01	±0,003	6	91	53	43	36	B093505-6.010+3-3AR	31178568
6,02	±0,003	6	91	53	43	36	B093505-6.020+3-3AR	31178569
7,00	H7	8	91	53	43	36	B093505-7.000H7AR	31178669
7,98	±0,003	8	91	53	43	36	B093505-7.980+3-3AR	31178637
8,00	±0,003	8	91	53	43	36	B093505-8.000+3-3AR	31178639
8,00	H7	8	91	53	43	36	B093505-8.000H7AR	31178670
8,01	±0,003	8	91	53	43	36	B093505-8.010+3-3AR	31178640
8,02	±0,003	8	91	53	43	36	B093505-8.020+3-3AR	31178641
9,00	H7	10	103	61	49	40	B093505-9.000H7AR	31178671
9,54	±0,003	10	103	61	49	40	B093505-9.540+3-3AR	31178647
10,00	±0,003	10	103	61	49	40	B093505-10.000+3-3AR	31178651
10,00	H7	10	103	61	49	40	B093505-10.000H7AR	31178672
10,01	±0,003	10	103	61	49	40	B093505-10.010+3-3AR	31178652
10,02	±0,003	10	103	61	49	40	B093505-10.020+3-3AR	31178653
11,98	±0,003	12	118	71	56	45	B093505-11.980+3-3AR	31178655
11,99	±0,003	12	118	71	56	45	B093505-11.990+3-3AR	31178656
12,00	±0,003	12	118	71	56	45	B093505-12.000+3-3AR	31178657
12,00	H7	12	118	71	56	45	B093505-12.000H7AR	31178673
12,01	±0,003	12	118	71	56	45	B093505-12.010+3-3AR	31178658
12,02	±0,003	12	118	71	56	45	B093505-12.020+3-3AR	31178659
12,70	±0,003	14	124	77	60	45	B093505-12.700+3-3AR	31178663
14,00	H7	14	124	77	60	45	B093505-14.000H7AR	31178674
16,00	H7	16	133	83	63	48	B093505-16.000H7AR	31178675

Drill-Reamer-Pyramid | B093505 (5xD), internal coolant supply, with pyramid tip

Configurable features



Bore diameter Tolerance \geq IT7:

- Diameter in increments of 0.001 mm freely selectable
- Can be ordered in tolerance \geq IT7

Specification:
B093505-[Diameter][Tolerance]AR



G-variant (see page 11):

- Diameter in increments of 0.001 mm freely selectable
- Can be ordered in tolerance \geq 6 μ m

Specification G-Variant:
B093505-[Diameter][Tolerance]AR

Dimensions configurable series IT7 and G-variant

d_1	d_2 h6	l_1	l_2	l_3	l_4
3,970 - 4,800	6	74	36	29	36
4,801 - 6,050	6	91	53	43	36
6,051 - 8,050	8	91	53	43	36
8,051 - 10,050	10	103	61	49	40
10,051 - 12,050	12	118	71	56	45
12,051 - 14,050	14	124	77	60	45
14,051 - 16,050	16	133	83	63	48

Example Tolerance IT7:

B093505-11.530H7AR

Bore diameter $d_1 = 11,530$ H7

Example G-variant:

B093505-11.530+3-3AR

Special tool diameter $d_1 = 11,530 \pm 3 \mu$ m

Drill-Reamer

Drill Reamer

B093305 (5xD), internal coolant supply

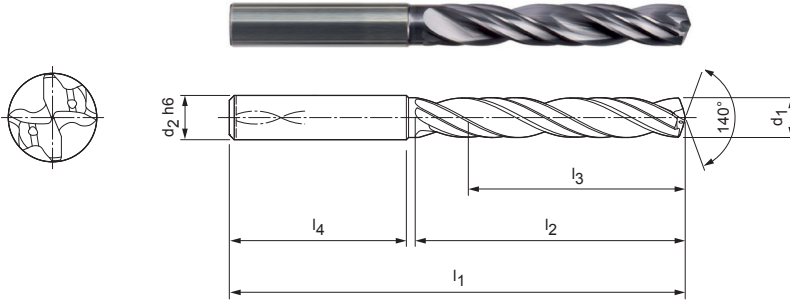

Design:

Drill diameter:	3,970 - 16,050 mm
Bore tolerance:	≥ IT 7
Cutting material:	Solid carbide, special TiAlN-Coating
Number of cutting edges:	2
Number of guiding chamfers:	4
Point geometry:	Specific geometry
Point angle:	140°
Helix angle:	30°



Preferred series in stock

Dimensions							Shank form HA	
d ₁	Tolerance	d ₂ h6	l ₁	l ₂	l ₃	l ₄	Specification	Order No.
4,00	H7	6	74	36	29	36	B093305-4.000H7AE	30134903
5,00	H7	6	91	53	43	36	B093305-5.000H7AE	30157641
6,00	±0,003	6	91	53	43	36	B093305-6.000+3-3AE	30120152
6,00	H7	6	91	53	43	36	B093305-6.000H7AE	30060348
6,01	±0,003	6	91	53	43	36	B093305-6.010+3-3AE	30120153
6,02	±0,003	6	91	53	43	36	B093305-6.020+3-3AE	30120154
7,00	H7	8	91	53	43	36	B093305-7.000H7AE	30076515
8,00	±0,003	8	91	53	43	36	B093305-8.000+3-3AE	30099663
8,00	H7	8	91	53	43	36	B093305-8.000H7AE	30072738
8,01	±0,003	8	91	53	43	36	B093305-8.010+3-3AE	30120194
8,02	±0,003	8	91	53	43	36	B093305-8.020+3-3AE	30120195
10,00	H7	10	103	61	49	40	B093305-10.000H7AE	30072099
10,01	±0,003	10	103	61	49	40	B093305-10.010+3-3AE	30120233
10,02	±0,003	10	103	61	49	40	B093305-10.020+3-3AE	30120234
12,00	±0,003	12	118	71	56	45	B093305-12.000+3-3AE	30120272
12,00	H7	12	118	71	56	45	B093305-12.000H7AE	30060349
12,01	±0,003	12	118	71	56	45	B093305-12.010+3-3AE	30120273
12,02	±0,003	12	118	71	56	45	B093305-12.020+3-3AE	30120274
14,00	H7	14	124	77	60	45	B093305-14.000H7AE	30060350
16,00	H7	16	133	83	63	48	B093305-16.000H7AE	30060351

Drill-Reamer | B093305 (5xD), internal coolant supply

Configurable features

**Bore diameter Tolerance \geq IT7:**

- Diameter in increments of 0.001 mm freely selectable
- Can be ordered in tolerance \geq IT7

**Specification:**

B093305-[Diameter][Tolerance]AE

G-variant (see page 11):

- Diameter in increments of 0.001 mm freely selectable
- Can be ordered in tolerance \geq 6 μ m

Specification G-variant:

B093305-[Diameter][Tolerance]AE

Dimensions configurable series IT7 and G-variant

d_1	d_2 h6	l_1	l_2	l_3	l_4
3,970 - 4,800	6	74	36	29	36
4,801 - 6,050	6	91	53	43	36
6,051 - 8,050	8	91	53	43	36
8,051 - 10,050	10	103	61	49	40
10,051 - 12,050	12	118	71	56	45
12,051 - 14,050	14	124	77	60	45
14,051 - 16,050	16	133	83	63	48

Example tolerance IT7:

B093305-11.530H7AE

Bore diameter $d_1 = 11,530$ H7**Example G-variant:**

B093305-11.530+3-3AE

Special tool diameter $d_1 = 11,530 \pm 3$ μ m

Drill-Reamer

Drill Reamer

B093303 (3xD), internal coolant supply

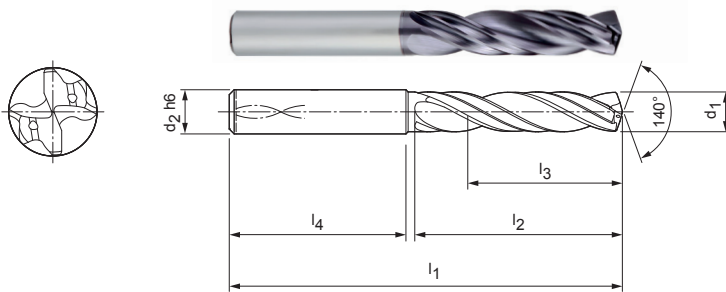

Design:

Drill diameter:	3,970 - 16,050 mm
Bore tolerance:	≥ IT 7
Cutting material:	Solid carbide, special TiAlN-Coating
Number of cutting edges:	2
Number of guiding chamfers:	4
Point geometry:	Specific geometry
Point angle:	140°
Helix angle:	30°



Preferred series in stock

Dimensions							Shank form HA	
d ₁	Tolerance	d ₂ h6	l ₁	l ₂	l ₃	l ₄	Specification	Order No.
4,00	H7	6	66	24	17	36	B093303-4.000H7AE	30115438
5,00	H7	6	79	34	24	36	B093303-5.000H7AE	30095401
6,00	±0,003	6	79	34	24	36	B093303-6.000+3-3AE	30119701
6,00	H7	6	79	34	24	36	B093303-6.000H7AE	30072761
6,01	±0,003	6	79	34	24	36	B093303-6.010+3-3AE	30119702
6,02	±0,003	6	79	34	24	36	B093303-6.020+3-3AE	30119703
7,00	H7	8	79	34	24	36	B093303-7.000H7AE	30076509
7,98	±0,003	8	79	34	24	36	B093303-7.980+3-3AE	30119739
8,00	±0,003	8	79	34	24	36	B093303-8.000+3-3AE	30095195
8,00	H7	8	79	34	24	36	B093303-8.000H7AE	30072737
8,01	±0,003	8	79	34	24	36	B093303-8.010+3-3AE	30119740
8,02	±0,003	8	79	34	24	36	B093303-8.020+3-3AE	30119741
9,99	±0,003	10	89	47	35	40	B093303-9.990+3-3AE	30119780
10,00	±0,003	10	89	47	35	40	B093303-10.000+3-3AE	30119781
10,00	H7	10	89	47	35	40	B093303-10.000H7AE	30072858
10,01	±0,003	10	89	47	35	40	B093303-10.010+3-3AE	30119782
10,02	±0,003	10	89	47	35	40	B093303-10.020+3-3AE	30119783
12,00	±0,003	12	102	55	40	45	B093303-12.000+3-3AE	30119832
12,00	H7	12	102	55	40	45	B093303-12.000H7AE	30072857
14,00	H7	14	107	60	43	45	B093303-14.000H7AE	30060346
16,00	H7	16	115	65	45	48	B093303-16.000H7AE	30060347

Drill-Reamer | B093303 (3xD), internal coolant supply

Configurable features



Bore diameter Tolerance \geq IT7:

- Diameter in increments of 0.001 mm freely selectable
- Can be ordered in tolerance \geq IT7

Specification:
B093303-[Diameter][Tolerance]AE



G-Variant (see page 11):

- Diameter in increments of 0.001 mm freely selectable
- Can be ordered in tolerance \geq 6 μ m

Specification G-variant:
B093303-[Diameter][Tolerance]AE

Dimensions configurable series IT7 and G-variant

d_1	d_2 h6	l_1	l_2	l_3	l_4
3,970 - 4,800	6	74	36	29	36
4,801 - 6,050	6	91	53	43	36
6,051 - 8,050	8	91	53	43	36
8,051 - 10,050	10	103	61	49	40
10,051 - 12,050	12	118	71	56	45
12,051 - 14,050	14	124	77	60	45
14,051 - 16,050	16	133	83	63	48

Example Tolerance IT7:

B093303-11.530H7AE

Bore diameter $d_1 = 11,530$ H7

Example G-variant:

B093303-11.530+3-3AE

Special tool diameter $d_1 = 11,530 \pm 3 \mu\text{m}$

Drill-Reamer

Drill-Reamer

B093301 (3xD), external coolant supply

Design:

Drill diameter: 3,970 – 16,050 mm
 Bore tolerance: ≥ IT 7
 Cutting material: Solid carbide, special TiAlN-Coating
 Number of cutting edges: 2
 Number of guiding chamfers: 4
 Point geometry: Specific geometry
 Point angle: 140°
 Helix angle: 30°

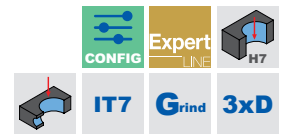
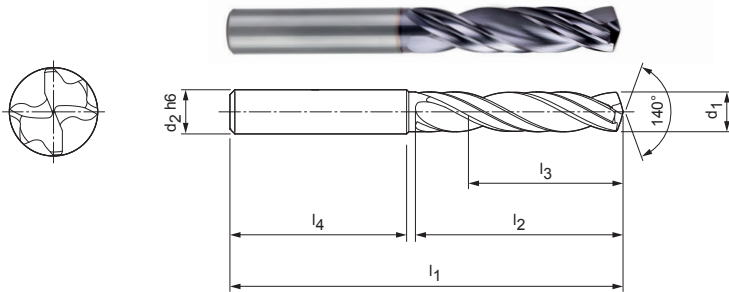

Preferred series in stock

Dimensions							Shank form HA	
d ₁	Tolerance	d ₂ h6	l ₁	l ₂	l ₃	l ₄	Specification	Order No.
5,99	±0,003	6	79	34	24	36	B093301-5.990+3-3AE	30184711
6,00	±0,003	6	79	34	24	36	B093301-6.000+3-3AE	30099666
6,02	±0,003	6	79	34	24	36	B093301-6.020+3-3AE	30219852
8,00	±0,003	8	79	34	24	36	B093301-8.000+3-3AE	30175468
10,00	±0,003	10	89	47	35	40	B093301-10.000+3-3AE	30099665

Configurable features



G-variant:
 - Diameter in increments of 0.001 mm freely selectable
 - Orderable from tolerance ≥ 6 µm

Specification G-Variant:
 B093301-[Diameter][Tolerance]AE

Configurable features G-variant

d ₁	d ₂ h6	l ₁	l ₂	l ₃	l ₄
3,970 - 4,800	6	74	36	29	36
4,801 - 6,050	6	91	53	43	36
6,051 - 8,050	8	91	53	43	36
8,051 - 10,050	10	103	61	49	40
10,051 - 12,050	12	118	71	56	45
12,051 - 14,050	14	124	77	60	45
14,051 - 16,050	16	133	83	63	48

Example G-variant:

B093301-11.530+3-3AE

Special tool diameter d₁ = 11,530 ±3 µm

Cutting data

Cutting speed v_c [m/min], feed f [mm/rev]

Drill-Reamer-Pyramid | B093505

Drill-Reamer | B093305, B093303, B093301

MG*	Material	Strength/ Hardness [N/mm ²] [HRC]	v_c [m/min]		Feed f [mm/rev] for drill diameter						
			Internal coolant	External coolant	4,00	6,00	8,00	10,00	12,00	16,00	
P	P1.1	Structural, free-cutting, case-hardening and heat-treatable steels, unalloyed	< 700	90	70	0,10	0,12	0,15	0,18	0,22	0,24
	P1.2	Structural, free-cutting, case-hardening and heat-treatable steels, unalloyed	< 1.200	80	60	0,12	0,15	0,19	0,23	0,27	0,30
	P2.1	Nitriding, case-hardening and heat-treatable steels, alloyed	< 900	90	70	0,11	0,14	0,18	0,22	0,26	0,29
	P2.2	Nitriding, case-hardening and heat-treatable steels, alloyed	< 1.400	65	50	0,10	0,12	0,15	0,17	0,20	0,23
	P3.1	Tool, rolling bearing, spring and high-speed steels**	< 800	70	50	0,10	0,13	0,16	0,20	0,23	0,26
	P3.2	Tool, rolling bearing, spring and high-speed steels**	< 1.000	55	45	0,09	0,11	0,13	0,16	0,19	0,21
	P3.3	Tool, rolling bearing, spring and high-speed steels**	< 1.500	55	35	0,07	0,09	0,11	0,13	0,15	0,16
P5	P5.1	Cast steel		90	70	0,11	0,14	0,18	0,22	0,26	0,29
K	K1.1	Cast iron with lamellar graphite (grey cast iron), GJL	< 300	110	70	0,14	0,18	0,24	0,30	0,35	0,40
	K2.1	Cast iron with nodular graphite, GJS	< 500	145	80	0,14	0,18	0,23	0,28	0,33	0,37
	K2.2	Cast iron with nodular graphite, GJS	≤ 800	90	60	0,12	0,16	0,20	0,24	0,28	0,32
	K2.3	Cast iron with nodular graphite, GJS	> 800								
	K3.1	Cast iron with vermicular graphite, GJV; malleable cast iron, GJM	< 500	80	65	0,13	0,17	0,21	0,26	0,30	0,34
	K3.2	Cast iron with vermicular graphite, GJV; malleable cast iron, GJM	> 500	70	55	0,11	0,14	0,17	0,21	0,24	0,27

Explanation

Pictograms



Product with Configurable features



Expert Line:
Specialist tools for selected applications
maximum precision and productivity



Drill ream
H7



Cross drilling



Inclined bore entry



Inclined Bore exit



Maximum achievable bore tolerance ≥ IT



Preferred series in H7



Tolerance tool grinding diameter



Maximum drilling depth



Coolant supply

Material suitability

Ideally suited
 Conditionally suitable

Ex. standard material suitability table

P	1	2	3	4	5	6	M	1	2	3	K	1	2	3	N	1	2	3	4	S	1	2	3	4	5	H	1	2	3

Explanation G-variant: Permissible workpiece tolerances for selecting the tool diameter.
 Design G-variant: The G-variant specifies the tool diameter of the reamer with our manufacturing tolerances.

The values given are guide values. The optimum data for the respective machining case may deviate slightly.
 * BECK machining groups
 ** If the alloy components Cr, Mo, Ni, V, W are > 8 % in total, then select the next higher machining group.

Your specialist for
Multi-bladed Reamers and Counterboring Tools

Drill-Reamers

High Performance Reamers
with internal coolant supply in a monobloc design
and modular system

Machine Reamers without internal coolant supply
in accordance with DIN or similar to DIN

Hand Reamers and Taper Reamers

Core Drills

Countersinks / Counterbores / Deburring Tools

beck.mapal.com