

# INDUSTRIAL GRINDING TOOLS



Vitrified and resin bonded.







# WHY WEILER

As an industry leader and global manufacturer of surface conditioning solutions, Weiler Abrasives is dedicated to forging collaborative relationships with our customers to tackle their toughest cleaning, grinding, cutting, deburring, and finishing challenges.

Weiler's **heritage dates to 1879**. Today, the tradition of excellence continues under the leadership of the fourth generation, Chris Weiler, President/CEO. Having grown from a power brush manufacturer to a global surface conditioning problem-solver, Weiler's mission is to partner with our customers and distributors to ensure their businesses stay productive and profitable. Our people, products and our strong desire to win deliver a competitive edge for our partners.

Weiler products are designed with productivity in mind.

**Work Faster:** Weiler products are designed to provide superior performance through maximum aggression and long life. That means you get your work done faster and more efficiently.

**Work Safer:** Weiler products are designed and manufactured to the strictest standards to ensure the highest level of quality and safety.

**Work Better:** We partner with you to improve your productivity and drive cost out of your business.

Weiler shares your goals of growth and profitability. For both, you need the right tools for the job. We don't just supply those products — we work with you to create solutions. Because that's what you deserve from a partner.

**Weiler. Your partner in success.**



# PRODUCT RANGE

Grinding belongs among those cutting procedures in which the tool has many cutting edges that are irregular in shape and act as turning knives during grinding. Grinding is performed at very high speeds, up to 125 m/s.

It can be divided into coarse, fine, honing and finishing. The following effects can be achieved:

- High material removal rates
- Very smooth surfaces
- High dimensional accuracy
- Ability to work very hard materials

The main motion involved is tool rotation.

With regard to the type and feed of workpiece and tool motion, grinding is divided into:

- High material removal rates
- Surface grinding
- Cylindrical grinding
- Tool sharpening

Grinding tools are bonded abrasives. The quality and applicability of an abrasive depend on the quality and the specification ratios of abrasive grit, the bonding material and pores. The specification of an abrasive is determined by:

- Abrasive grit quality
- Abrasive grit size
- Hardness
- Structure
- Bonding material

## FINE GRINDING:

- Peripheral surface grinding
- Surface grinding with grinding segments, rings and cups
- Double disc surface grinding
- Springs grinding
- External cylindrical grinding
- Centerless external cylindrical grinding
- Flute grinding
- Internal cylindrical grinding
- Tool grinding and sharpening
- Gear grinding
- Manual grinding on stationary grinding machines
- Manual grinding with mounted points
- Cutting
- Honing.

## COARSE GRINDING:

- Grinding wheels for snagging
- Hot pressed snagging wheels
- Cutting with enforced cut-off discs

## APPLICATIONS:

- Steel plants
- Foundries
- Shipbuilding
- Automotive industry
- Toolmaking
- Civil engineering and construction
- Agriculture
- Food industry
- Glassmaking
- Stonecutting
- Arts and crafts.

# THINK SAFETY

## MARKING ON WHEELS

### WARNINGS FOR SAFE USE

-  ..... Please read the instructions carefully
-  ..... Use a safety shield or protective eyewear
-  ..... Use ear protection
-  ..... Use protective gloves
-  ..... Use a dust mask
-  ..... Free hand grinding or cutting prohibited
-  ..... Use of damaged products prohibited



## USE AND MARKING OF GRINDING TOOLS

Responsibility for safety during grinding:

### Grinding machine manufacturer

The machine manufacturer must ensure machine stability, strength of the protective housing, as well as the possibility of setting machine strokes and displacements to enable the desired grinding precision, and should also attach instructions for precise and safe work.

### Grinding tool manufacturer

The tool manufacturer must produce safe grinding wheels and ensure that the ingredients are properly selected, including correct technological manufacturing procedure and the necessary product control:

- safety speed control (increased peripheral speed, sound, cracks)
- quality control (dimensions, hardness, whipping and balance)

The control methods are prescribed in the international standards EN 12413 and EN 13236, FEPA and ISO.

- Manufacturer's name
- Grinding wheel dimensions
- Grinding wheel specification (type and size of abrasive grit, hardness, structure and bond)
- Max. operating speed
- Warnings regarding grinding wheel use

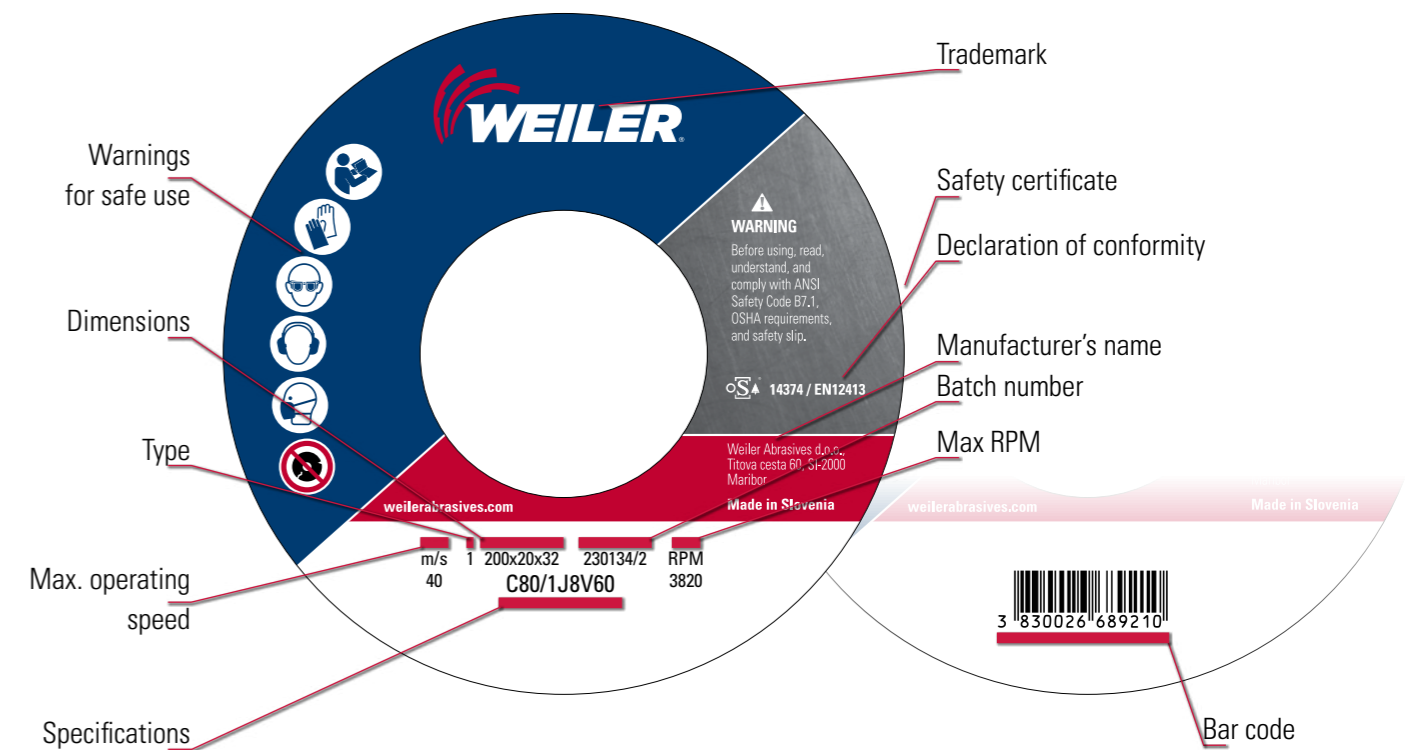



## GRINDING WHEEL OPERATING SPEEDS AND RPM

For individual grinding wheel diameters and operating speeds, the number of revolutions per minute (RPM) is determined from the table below.

D (mm)	Peripheral speed (m/s)												
	12	16	20	25	32	35	40	45	50	63	80	100	125
3	76390	101860	127320	195160	203720	222810							
6	38200	50290	63360	79580	101860	114410	127320	143240	159160	200540	254650		
8	28650	38200	47750	59680	76390	83560	95490	107430	119370	150400	190990	238730	
10	22920	30560	38200	47750	61120	66850	76390	85940	95490	120320	152790	190990	238730
13	17630	23510	29380	36730	47010	51420	58770	66110	73460	92560	117530	146910	183640
16	14320	19100	23870	29840	38200	41780	47750	53710	59680	75200	95490	119340	149210
20	11460	15270	19100	23870	30560	33420	38200	42970	47750	60160	76390	95490	119340
25	9170	12220	15280	19100	24450	26740	30560	34380	38200	48130	61120	76390	95490
32	7160	9550	11940	14920	19100	20890	23870	26860	29840	37600	47750	59680	74600
40	5730	7640	9550	11940	15280	16710	19100	21490	23870	30080	38200	47750	59680
50	4580	6110	7640	9550	12220	13370	15280	17190	19100	24060	30560	38200	47750
63	3640	4850	6060	7580	9700	10610	12130	13640	15160	19100	24250	30320	37890
80	2870	3820	4780	5970	7640	8360	9550	10740	11940	15040	19100	23870	29840
100	2290	3060	3820	4780	6110	6680	7640	8590	9550	12030	15280	19100	23870
125	1830	2440	3060	3820	4890	5350	6110	6875	7640	9630	12220	15280	19100
150	1530	1040	2550	3180	4070	4460	5090	5730	6370	8020	10190	12730	15920
175	1310	1850	2180	2730	3490	3820	4370	4910	5460	6880	8730	10910	13640
180	1270	1700	2120	2650	3400	3710	4240	4775	5310	6680	8490	10610	13260
200	1150	1530	1910	2390	3060	3340	3820	4230	4780	6020	7640	9550	11940
230	1000	1330	1660	1080	2660	2910	3320	3740	4150	5230	6640	8300	10380
250	920	1230	1530	1910	2440	2670	3060	3440	3820	4810	6110	7640	9550
300	765	1020	1270	1590	2040	2230	2550	2865	3180	4010	5090	6370	7960
350	655	875	1090	1365	1745	1910	2180	2455	2730	3440	4370	5460	6820
400	575	765	955	1195	1530	1670	1910	2150	2390	3010	3820	4780	5970
450	510	680	850	1060	1360	1485	1700	1910	2120	2670	3400	4240	5300
500	460	610	765	955	1220	1335	1530	1720	1910	2410	3060	3820	4780
600	380	510	640	795	1020	1115	1290	1430	1590	2000	2550	3180	2980
650		470	588	735	940	1030	1180	1320	1470	1850	2350	2940	
700		437	546	682	873	955	1090	1230	1360	1720	2180	2730	
750		407	509	637	815	891	1020	1150	1270	1600	2040	2550	
800		328	477	597	764	836	955	1070	1190	1500	1910	2390	
900		340	424	531	679	743	849	955	1060	1340	1700	2120	
1060		288	360	450	577	631	721	811	901	1140	1440	1800	
1250		245	305	380	488	534	610	685	760	960	1020	1525	

v - peripheral speed (m/s)

d - grinding wheel diameter (mm)

n - revolutions per minute (rpm)

The peripheral speed of a grinding wheel is determined according to the following equation:

$$v = \frac{d \cdot \pi \cdot n}{60000}$$

Grinding tools without special designations are intended for operating speeds of up to 45 m/s.

Grinding wheels for greater operating speeds may be designated with a diagonal color line, as follows:



## INSPECTION AND MOUNTING OF GRINDING TOOLS

During work, users must follow the instructions of the tool and machine manufacturer(s), and most importantly:

- Provide adequate storage for the grinding tools
- Inspect grinding tools before mounting
- If necessary, balance and correctly mount grinding tools
- Correctly prepare the grinding machine
- Test the grinding tool while unloaded

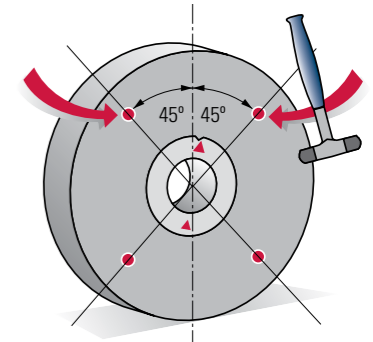

Grinding tools are usually stored in cardboard packaging or wooden cases and shipped on wooden pallets. Packaging does provide for safe transport; nevertheless the cartons or cases must not be thrown during reloading. After their receipt at the warehouse and especially directly before mounting onto the grinding machine, the grinding tool must be inspected; circular grinding tools must also be ring tested to detect any damage that may have occurred during transport or storage. Ring testing of grinding tools is performed by lightly hitting a suspended tool in four places with a metallic or wooden hammer; the tool must yield a clear ringing sound. If the sound is dull, the tool is probably damaged.



Grinding tools must always be mounted by properly trained and experienced personnel. In addition to visual inspection and ring testing, dimensions, quality and max. peripheral speed also need to be checked prior to mounting. Grinding tools should be mounted easily on the spindle or a clamping device (without the use of force or hammering) and must ensure safe clamping. The enclosed cardboard flange should be placed between a grinding wheel and the clamping part (steel flange or clamping jaw). The permitted grinding wheel imbalance is calculated according to standard ISO 6103.

Grinding tools of greater dimensions, which are mounted on a flange and onto a machine spindle together with the flange, need to be statically balanced with flange weights.

If the grinding wheel is not statically balanced, vibrations appear during grinding; this causes greater tool wear, lower ground surface quality, and shorter life of the main machine spindle bearings; the wheel may also split during work due to centrifugal force.

The procedure for static balancing of the grinding wheel involves manual positioning of weights into flange grooves, so that the total mass of the wheel and weights is evenly distributed along the circumference.

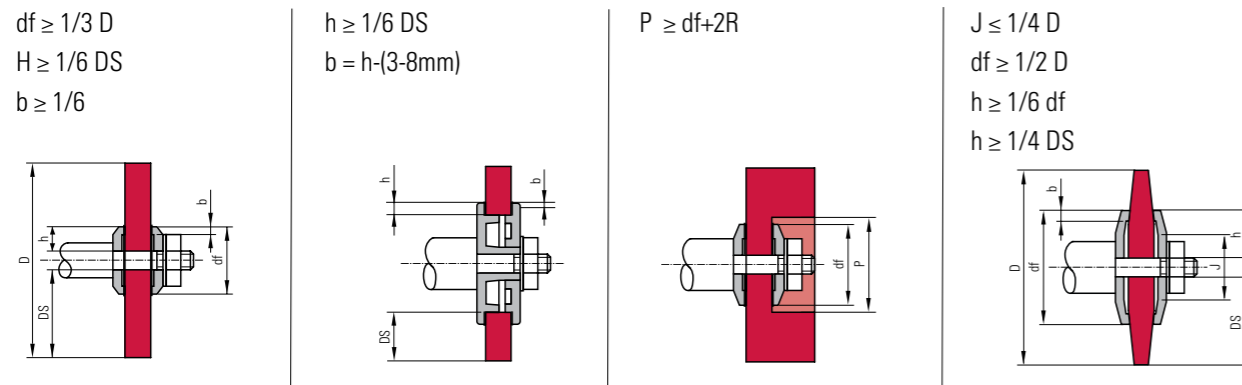

## START OF GRINDING

After mounting, and before grinding can begin, the following operations need to be performed:

- Set the machine so that it rotates at the maximum operating speed and appropriately protects the danger zone.
- Switch the machine on and leave the wheel to rotate for 1 minute prior to grinding.
- Prepare the coolant.
- Dress the grinding tool (diamond dressing tool).

**Incorrect handling may cause damage to the grinding wheel or machine, or a work accident.**

## GENERAL RECOMMENDED GRINDING PARAMETERS FOR INDIVIDUAL TYPES OF GRINDING:

Application	Grinding wheel periph. speed (m/s)	Workpiece periph. speed (m/min)	Longitudinal motion (m/min)	Transverse feed (mm/min)	Grinding feed (mm)
<b>Surface grinding</b>					
- general applications	25 - 30	/	5 - 20	(0.25 - 0.33) * T	0,01 - 0.03
- for high-alloyed steel	23 - 28				
- for cast iron	20 - 25				
- for tungsten carbides	15 - 20				
- for non-ferrous metals	15 - 20				
<b>External cylindrical grinding</b>					
- for coarse types of grinding intended for cleaning purposes	25 - 32	5 - 20	2 - 5 mm / workpiece revolution	/	0.005 - 0.03
- for dressing	25 - 32				
- for fine grinding	20 - 30 (63)				
- for the finest grinding	12 - 18				
<b>Centerless external cylindrical grinding</b>					
- general applications	30 - 40 (63)	10 - 50	Guide plate angle $\alpha = \text{do } 5^\circ$	/	0.005 - 0.03
<b>Circular grinding - internal cylindrical grinding</b>					
- general applications	25 - 32	5 - 15	/	/	0.005 - 0.03
- for high-alloyed steel	15 - 20				
- for cast iron	15 - 20				
- for tungsten carbides	8 - 15				
- for non-ferrous metals	15 - 20				
- bearings	63 - 80				
<b>Tool sharpening</b>					
- for tool steels	25 - 30	/	/	/	0.005 - 0.015
- for high-speed steels	25 - 30				
- for tungsten carbides	8 - 15				



# GRINDING WHEELS FOR STEEL PLANTS



## HOT-PRESSED STEEL CONDITIONING WHEELS

Hot-pressed grinding wheels are used for removal of hard oxide crust in the process of steel manufacture (slabs, billets) and rough grinding.

### Grinding wheels 1VS

D x T x H

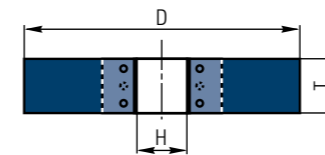

#### Available sizes D x H x T (mm)

920 x 102 x 305 (400)
920 x 125 x 305 (400)
920 x 150 x 305 (400)



#### Available sizes D x H x T (mm)

610 x 65 x 203.2 (304.8)
610 x 76 x 203.2 (304.8)
610 x 102 x 203.2 (304.8)
610 x 124 x 203.2 (304.8)
635 x 76 x 304.8

### ADVANTAGES:

- Up to 20% greater grinding efficiency than previous generation
- Improved surface finish
- Custom engineered to meet specific application requirements

### ADVANCED ABRASIVE MATERIALS FOR YOUR APPLICATION

- Fused aluminium oxide
- Silicon carbide
- Blocky zirconia aluminium
- Sintered aluminium oxide
- Sintered bauxite





# ROLL GRINDING

WEILER is a manufacturer of grinding wheels for grinding new rolls when they are being made and also for grinding used rolls for their renewal.  
 At the Producers of rolls we meet with Casted and Forged rolls. Vitrified bonded wheels as well resin bonded wheels are used for the grinding.  
 In Steel Plants WEILER produces wheels for correction of topographic shape and to get it into dimensional and surface tolerances.

## ADVANTAGES:

- Lower production costs
- Less power consumption
- Less downtime for change overs
- Faster material removal rate up to + 30 %
- Increased G-ratio up to + 40 %
- Wheel life increase up to + 20 %
- All types of workpiece material
- High and low horsepower machines



**Grinding wheel 1**

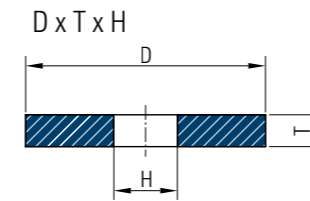

**Grinding wheels 5**

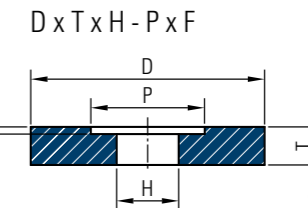

**Grinding wheels 7**

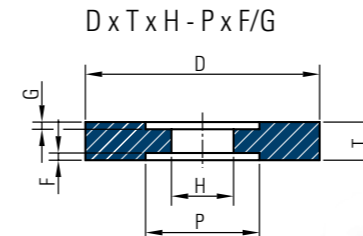

## DIMENSIONS

D (mm)	T (mm)	H (mm)
350	38	127
600	50, 60, 70, 100, 125	203.2, 304.8
700	60, 80, 100, 125	304.8
750	80, 100, 125	304.8
762	80, 100, 125	304.8
800	80, 100, 125	304.8
900	80, 100, 150	304.8
915	80, 100, 152	304.8, 355, 457.2, 508
1000 - 1100	60, 75, 80, 100, 127, 152	304.8, 355, 457.2, 508

## MACHINES

Waldrich, Herkules, Pomini, Landis, Schaudt, Churchill, Fortuna, Farrel, ...



# RECOMMENDATIONS FOR SPECIFICATIONS

## PRODUCTION OF ROLLS

Casted	Rough grinding	XXC 10 YBH
	Final grinding	C80/3H9V60
Forged steel	Rough grinding	3GAI60/9EF12/3VM97T9
	Final grinding	C120/1H11V60



## COLD MILLING

Roll type		Material	Hardness [HRc]	Surface Ra [µm] (#grit)	Standard	High Performance
COLD ROLLING MILLS	Working Rolls	Forged Cr steel HSS	52-61 59-65	0,4 - 0,8 (#46) 0,3 - 0,6 (#60) 0,2 - 0,4 (#80) 0,16 - 0,10 (#120) 0,09 - 0,05 (#180)	82A/8A/18HA 46-100F-JBK	38HA46 - 180F - JBK
	Back up Rolls	All	up to 65		18HA46 - 100H - JBK	38HA46 - 100H - JBK

## STEEL PRODUCTION

### HOT MILLING

Roll type		Materials	Ra [µm]	Standard Quality	High Performance
HOT MILLING ROLLS	Working Rolls	Indefinit	0,4 - 0,8 0,6 - 1,2	S1HC 30-46/1 J-K7 BK22L	S3HC 30-46/1 J-K7 BK22L
		HardGuss Ductile iron Sferic iron	0,4 - 0,8 0,6 - 1,3	S9C30-46/1L7BX03L	S2HC 36/1 J-L7 BK22L
		HSS High-Cr iron High-Cr steel	0,4 - 0,8 0,6 - 1,4	S28HA36-46/1 I-J-K BK22L	S48HA 36 /1 I-J-K7 BK22L
		All Materials	0,4 - 0,8 0,6 - 1,4	S25HC 36/1J-K 7 BK22L	S4HC 36-46/9 I-J-K 7 BK22L
	Back up Rolls	HSS High-Cr iron High-Cr steel		S28HA36-46/1 I-J-K BK22L	S48HA 36 /1 I-J-K7 BK22L

### GRINDING OF RUBBERED ROLLS

Hard rubber	2A30/1G13/1V
Hard rubber - fine grinding	2A54/1G13/1V
Soft rubber	21A24/1I7+V
Soft rubber - fine grinding	C60/1G13/1V
Calender rolls	8A60/1H8/6V

### COPPER AND ALUMINIUM MILLS

Plate	2A60 - 80 H10/3V35 (standard)	8A54 - 60I7V835 (high stock removal)
Sheet	9C150 - 180G-H10/3V35	
Aluminum foil	SC220/1D11BK03L	



# CENTERLESS-CR

## RESIN BONDED GRINDING WHEELS



These grinding wheels are used for the mass production roughing and finishing of steel bars or cylindrical shaped workpieces

**Resin bonded wheels for trough-feed centerless grinding**



### FEATURES:

- faster material removal
- good surface quality after fine grinding
- achieving high-accuracy roundness and cylindricity of the workpiece and good dimension accuracy
- good profile holding capability and long lifetime of the wheel
- grinding application from rough, medium to fine grinding.

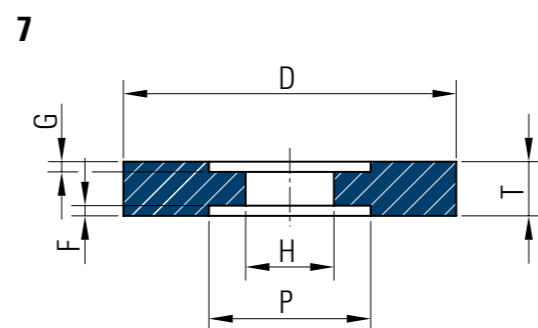
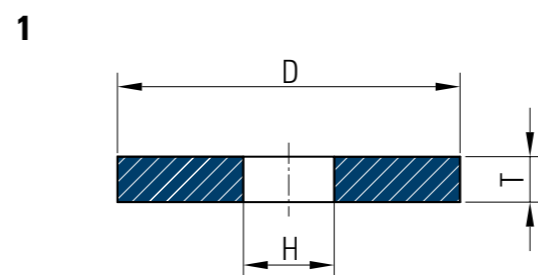

Shape	Dimensions (D x T x H) mm
1	400 x 200 x 203,2
7	500 x 250 x 254-355 x 25/25
1	600 x 250 x 355
1RS	610 x 508 x 304,8

Material	Specification	Surface finish (Ra)
Stainless Steel	SC 46/2 L7 BX23	0,8
Carbon Steel	S57 C70-90/2 J9BX23	0,3 - 0,4



# LARGE REINFORCED CUTTING-OFF WHEELS

Reinforced cutting-off wheels of large diameters are used for cutting products of large cross-sections in the manufacture of rolled profiles, forged pieces, pipes and rods.

Cutting on suspended and stable machines

Workpiece	Specification	D
Structural steel	A24S1BF	450 - 600
Stone, firebrick	C30PB3BF	450 - 600
Aluminium and colour metals	A24PSBF	450 - 600
Stainless steel	4A30N6BF	450 - 500
Stainless steel	7A24PBF	500 - 600
Steel and other alloys	WA24S1BF	500 - 600

Cutting of large cross-sections on stable machines

Cold cutting	WA20/24RBF	800
Warm cutting	WA20/24SBF	800
Hot cutting	WA20/24QBF	800



## Cutting-off wheels Type 41

D x T x H

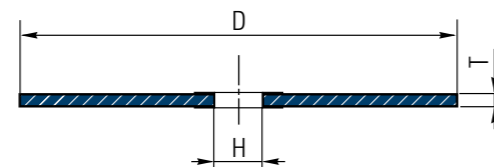

D	T	H
450	4 - 4,5	25.4 (32) (40)
500	5 - 6	25.4 (32) (40)
600	6 - 7	40 (60) (76.2) (80)
813	9/8.5*	80 (100) (152.4)

## Cutting-off wheels Type 42

D x T x H

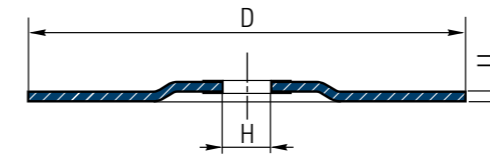

D	T	H
500	5 - 6	76,2
600	6 - 7	76,2





# GRINDING WHEELS FOR FOUNDRIES

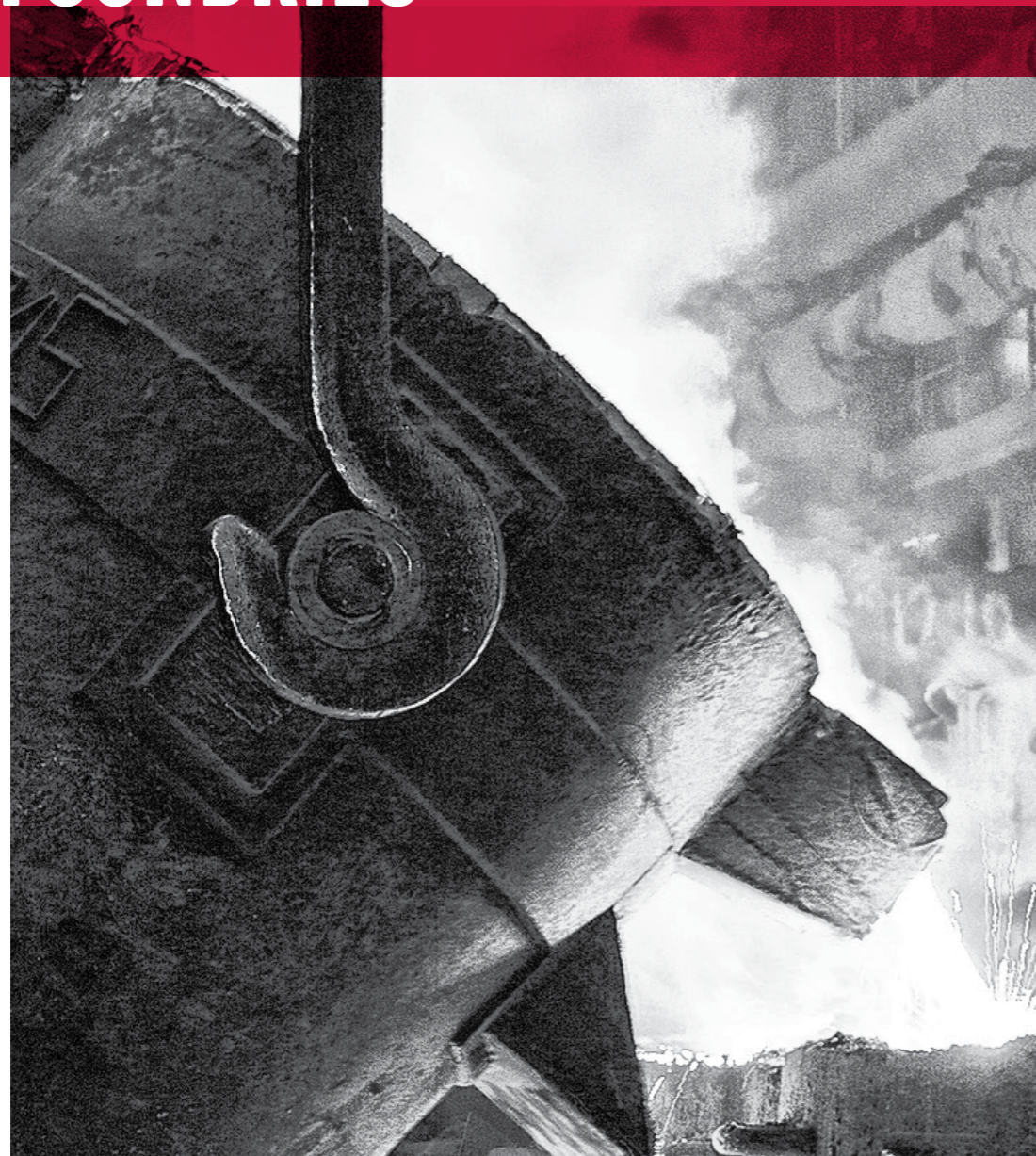

## GRINDING CONES WITH NUTS

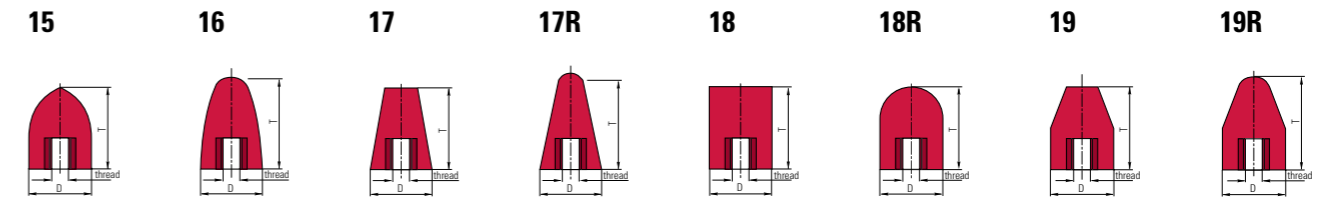

Intended for the **CONDITIONING** of casts and metal parts.

The selected grit size depends on the grinding cones diameter:



Ground material	Quality class/Specification	
	STANDARD	EXTRA
Steel	A20PB	ZA20PB
Gray, nodular and malleable casting	CA20PB	ZC20PB

Type	Dimensions D x T x thread mm	RPM min <sup>-1</sup>	Peripheral speed m/s	Packaging units pz.
15	40 x 63 x thread	23900	50	25
	50 x 80 x thread	19100		
	63 x 80 x thread	15200		
16	40 x 63 x thread	23900		
	50 x 80 x thread	19100		
	63 x 80 x thread	15200		
17	32 x 60 x thread	30000		
	40 x 63 x thread	30000		
	40 x 90 x thread	23900		
17R	50 x 100 x thread	19100		
	50 x 50 x thread	19100		
	63 x 80 x thread	15200		
18	80 x 100 x thread	12000		
	32 x 50 x thread	30000		
	40 x 60 x thread	23900		
	40 x 80 x thread	23900		
	50 x 50 x thread	23900		
18R	50 x 100 x thread	19100		
	40 x 60 x thread	23900		
	50 x 50 x thread	19100		
19	50 x 80 x thread	19100		
	40 x 50 x thread	23900		
	50 x 100 x thread	19100		

On customer request, grinding cones can also be produced with the following threads: M10 (3/8"), M12 (1/2"), M14 (5/8"), M16 (3/4")



# CONDITIONING GRINDING WHEELS

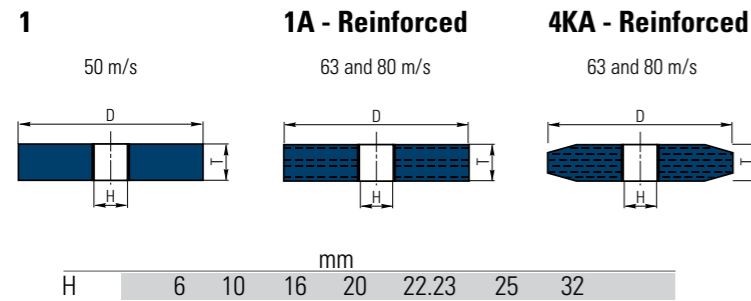

Specification	Hardness	Material	Performance class
	P-R	Steel	Standard
	P-Q	Cast iron steel	Standard
	Q-R	Stainless steel, casting	High performance
	Q-R	Grey cast	Standard

Type	Dimensions D x T x thread mm	RPM min <sup>-1</sup>	Peripheral speed m/s
1A	50 x 4 to 12 x H	24060/30560	63, 80
	60 x 4 to 12 x H	19100/25500	
	65 x 6 to 12 x H	18510/23500	
	70 x 6 to 12 x H	16040/21800	
1	75 x 20 to 25 x H	12750	50
1A	75 x 6 to 25 x H	16100/20400	63, 80
4KA	75 x 20 to 25 x H	20400	80
1	80 x 20 to 25 x H	12000	50
1A	80 x 4 to 25 x H	15100/19100	63, 80
4KA	80 x 20 to 25 x H	19100	80
1	100 x 15 to 25 x H	9550	50
1A	100 x 6 to 25 x H	12100/15300	63, 80
4KA	100 x 15 to 25 x H	15300	80
1	125 x 15 to 25 x H	7650	50
1A	125 x 15 to 25 x H	9650/12250	63, 80
4KA	125 x 15 to 25 x H	12250	80
1	150 x 20 to 30 x H	6400	50
1A	150 x 20 to 30 x H	8050/10200	63, 80
4KA	150 x 20 to 30 x H	10200	80
1	200 x 15 to 30 x H	4800	50
1A	200 x 15 to 30 x H	6050/7650	63, 80
4KA	200 x 15 to 30 x H	7650	80
1	250 x 20 to 25 x H	3850	50
1A	250 x 20 to 25 x H	4850/6150	63, 80
4KA	250 x 20 to 25 x H	6150	80

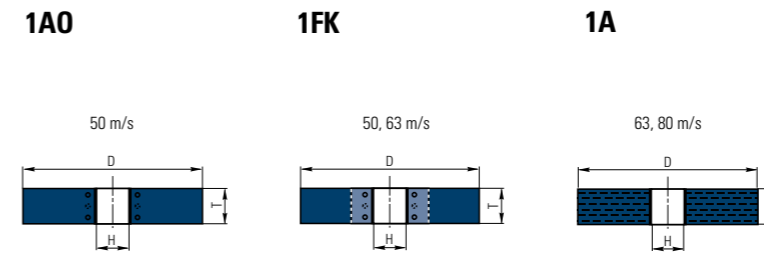

Specification	Hardness	Material	Performance class
3A14-24Q-R3-4BF	Q-S	Non-alloy and low-alloy steels	Standard
52A7A16-24Q-R3-4BF	Q-R	High-alloy steels	Standard
53C20-36N-R3-4BF	Q-R	Stainless steel, high-alloy steel	High performance
2ZA14-24N-R3-4BF	Q-R	Grey and nodular alloy	Standard
3A14-24Q-R3-4BF	Q-S	Tempered alloy	Standard
9C16-24Q-P3-4BF	Q-R	Aluminium and other colour metals	Standard
52A16-24Q-R3-4BF	Q-S	Stainless steel, steel, Casting	High performance

Type	Dimensions D x T x thread mm	RPM min <sup>-1</sup>	Peripheral speed m/s
1A	300 x 12 to 60 x H	4010/5100	63, 80
1FK	300 x 30 to 60 x H	3200/4050	50, 63
1AO	300 x 30 to 60 x H	3200	50
1A	350 x 25 to 60 x H	3440/4400	63, 80
1FK	350 x 30 to 63 x H	2750/3450	50, 63
1AO	350 x 30 to 100 x H	2750	50
1A	400 x 30 to 60 x H	3010/3850	63, 80
1FK	400 x 25 to 76 x H	2400/3050	50, 63
1AO	400 x 30 to 60 x H	2400	50
1A	450 x 25 to 60 x H	2670/3400	63, 80
1FK	450 x 30 to 65 x H	2150/2700	50, 63
1AO	450 x 40 to 65 x H	2150	50
1A	500 x 50 to 60 x H	2410/3100	63, 80
1FK	500 x 30 to 80 x H	1950/2450	50, 63
1AO	500 x 40 to 76 x H	1950	50
1A	600 x 40 to 80 x H	2000/2550	63, 80
1FK	600 x 40 to 80 x H	1600/2050	50, 63
1AO	600 x 50 to 100 x H	1600	50
1FK	700 x 60 x H	1360/1720	50, 63
1FK	750 x 50 to 90 x H	1270/1300	50, 63
1FK	800 x 60 to 100 x H	1190/1500	50, 63

# GRINDING WHEELS FOR SPRING INDUSTRY



## SPRING END GRINDING

**ICE SPRING** is our brand new product for spring ends grinding with innovative solutions the grinding bond, structure and abrasive grains that will reduce your grinding costs.

### ADVANTAGES:

- allows spring ends grinding up to 63m/s
- compliance to EN 12413
- increased productivity due to shorter grinding cycle
- extremely cool grinding process
- longer wheel life
- significantly less dressing adjustment required
- advanced self-sharpening grinding effect
- constant stability of the grinding process throughout the whole life of the wheel
- universal specification for stainless and carbon steel
- produced in all standard dimensions

### APPLICATIONS:

In terms of dimensions and shape, WEILER offers solutions for various machine types with diameters ranging from 300 mm to 1500 mm. Specially adjusted composition offers the highest level of grinding optimization.

35U

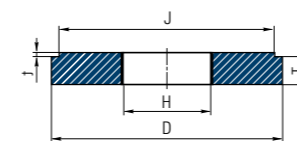

36

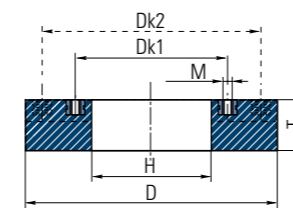



**Example:**

Dimensions:  
660x100x150-30/M10-15A  
Specification: ICE SPRING VA20BA1  
Machine: OMD MA10

Spring diameter: 40mm  
Wire diameter: 3,5mm  
High spring constant (stiffness)  
Steel grades: EN 14310

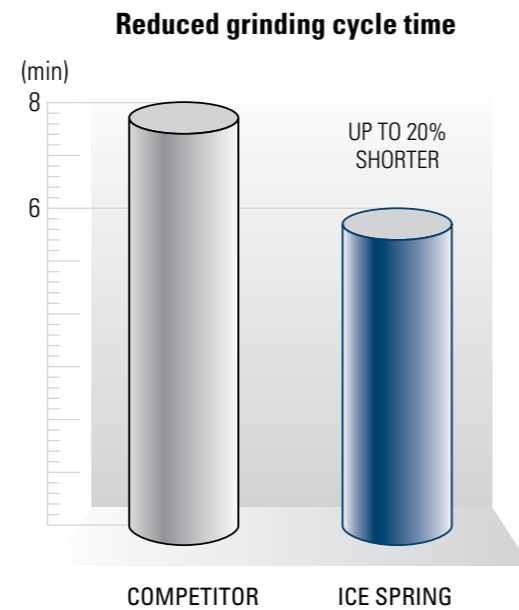
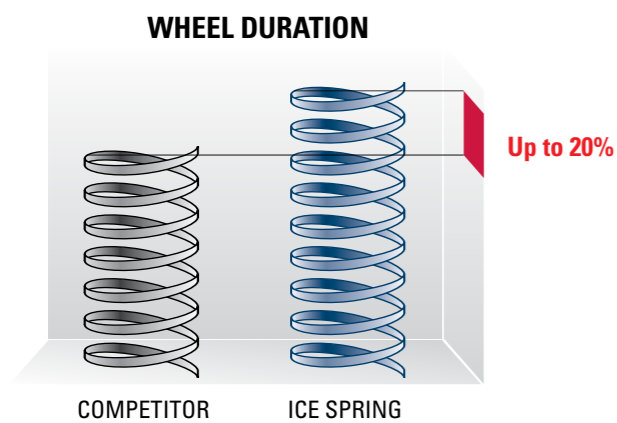

## EXTRA SPRING END GRINDING

WEILER boasts over 130 years of tradition in the manufacture of grinding wheels. Our latest, new range of products for spring grinding is the result of many years of experience and development. Combined with a correctly selected grain size, its new vitrified and resin based bonding system yields optimal grinding results.

**APPLICATIONS:**

In terms of dimensions and shape, WEILER offers solutions for various machine types and manufacturers, such as OMD, Kamatech, Wafios and others. Several grinding wheel variants with or without a hole, having diameters from 175 mm to 915 mm and appropriately adjusted compositions, have enabled us to achieve the highest level of grinding optimisation.

**APPLICATIONS:**

- minimal dressing frequency with permanent self sharpening
- longer wheel life
- minimal grinding pressures
- same specifications for stainless steel and carbon steel
- cool grinding up to 50 m/s

**EXAMPLE:**

Dimensions:  
660x100x150-30/M10-15A  
Specification: GA 20 Q BXV  
Machine: OMD 13  
Spring diameter: 17 - 35 mm  
Spring wire diameter: 4.5 – 5.5 mm  
High spring force  
Steel quality: DIN 17224

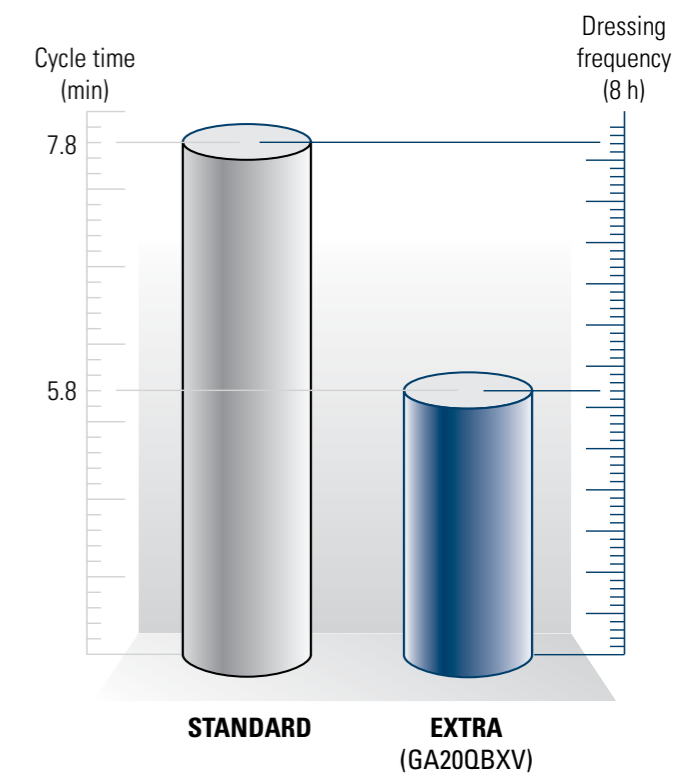
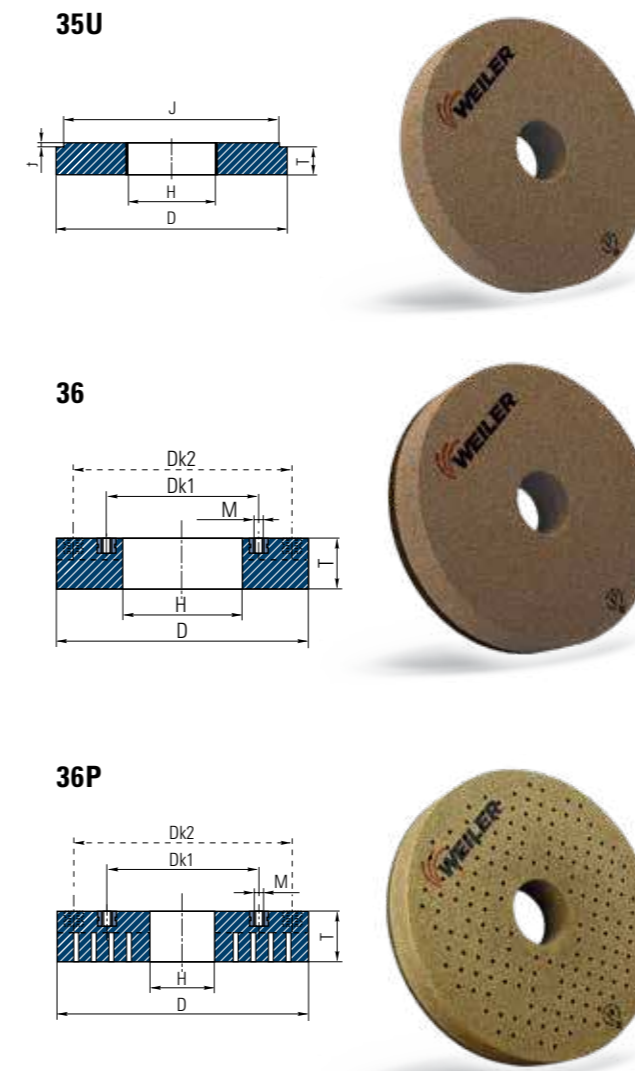



## GENERAL RECOMMENDATIONS



	Wire diameter		
	0,8 mm to 1,2 mm	3 mm to 6 mm	16 mm to 22 mm
ICE SPRING	VA46	VA30	VA16
EXTRA	VA46	VA30	VA16

Dimensions D x T x H (mm)Form 35U +36 + 36P	Cooling Holes	Nuts
150 x 30 x 20		
175 x 50 x 50	Mounting with flange	
175 x 50 x 0		✓
225 x 50 x 50	✓	
225 x 50 x 0		✓
400 x 60 x 250		
450 x 60 x 200	✓	✓
450 x 60 x 0	✓	✓
450 x 65 x 200		
450 x 80 x 40	✓	✓
450 x 80 x 0	✓	✓
600 x 70 x 250	✓	✓
600 x 75 x 250	✓	✓
600 x 80 x 250	✓	✓
600 x 80 x 300	✓	✓
650 x 80 x 350	✓	✓
650 x 80 x 0	✓	
650 x 90 x 350	✓	✓
660 x 100 x 150	✓	✓
660 x 120 x 150	✓	✓
650 x 100 x 350	✓	
800 x 100 x 400		✓
800 x 120 x 300		
915 x 120 x 200	✓	✓
1000x100/150 x 0/200/300	✓	✓





# GRINDING WHEELS FOR GEARS INDUSTRY



Weiler Gear grinding program named TOP GEAR offers grinding solutions that delivers a competitive edge through increased productivity and profitability.

Increased productivity is achieved with selected combinations of sol-gel and or microcrystalline abrasive grains combined with synthetic re-crystallized »SHARPIO« bonding system. Customer gets additional features and benefits:

- Excellent profile retention
- Working speeds up to 80m/s
- No overheating of workpiece
- Reduced grinding time
- Longer service life
- Low wear of diamond dressing tools
- Tailor made products – designed for your application
- Stock – possibility to have wheels on stock

## CONTINUOUS GEAR GRINDING

Wheels can be supplied blank or with profile up to 7 starts, module from 0,5 up to 10 in desirable pressure angle (PA°) and lead orientation (left, right).

Wheels are made in dimensions suitable for all major grinding machine brands like Reishauer, Liebherr, Kapp- Niles, Gleason, Samputensili, etc.

1Z D x T x H - M/V°

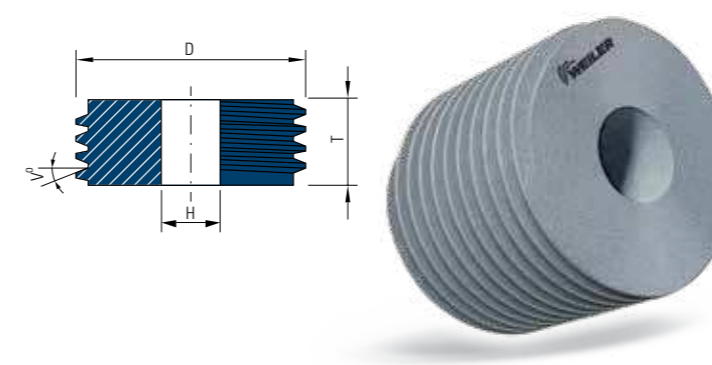

D	T	H
100-450	25-300	76,2/203,2

Customer defines: - nr. of starts (1 - 7)  
- lead orientation  
- modul  
- profile angle

Example: 1Z3 320 x 230 x 110 - M4/V22°

QUALITY	ABRASIVES	GRANULATION	MODUL	HARDNESS	STRUCTURE	BINDER	SPEEDS
TOP GEAR 1	Ceramic abrasives blends	100-80 120-100 150-120	3 - max 10 1,25 - 3 0,5 - 1,25	G-H-I	11-14	V57	up to 80 m/s
TOP GEAR 2	Microcrystalline abrasive blends						
TOP GEAR 3	Conventional abrasives blends						



## PROFILE GEAR GRINDING

Wheels can also be supplied blank or pre-profiled in ISO type 4 or 7 given all required geometrical dimensions. Wheels are made in dimensions suitable for all major grinding machine brands like Gleason, Hofler, Kapp-Niles, Samputensili, Luren, etc..

4N - D x T x H - U... V°

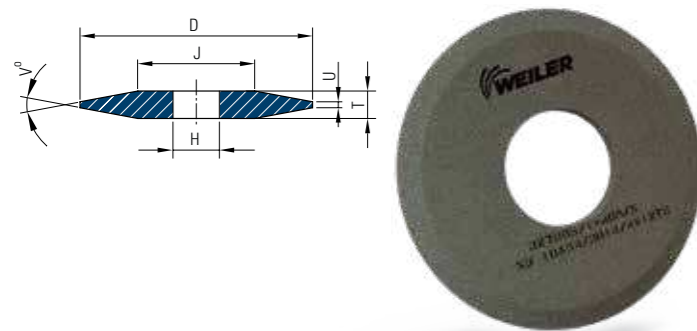

D	T	H
120-500	30-130	50,8/76,2/90/127

Customer additionally defines:

- angle (V°) according to drawing
- tip width (U) according to drawing

Example: 4N - 400 x 30 x 127 - V40°

QUALITY	ABRASIVES	GRANULATION	MODUL	HARDNESS	STRUCTURE	BINDER	SPEEDS
TOP GEAR 1	Ceramic abrasives blends	#60 #60-80 #80-100 #100-120	>10	G-H-I	11-14	V	up to 63 m/s
TOP GEAR 2	Microcrystalline abrasive blends		6-10				
TOP GEAR 3	Conventional abrasives blends		3-6 <1 up to 3				

## BEVEL GRINDING

Wheels can be supplied blank or pre-profiled given all required geometrical dimensions. Wheels are made in dimensions suitable for machines like Gleason Phoenix and Klingelberg Oerlikon. We also provide metal carriers.

2Z - D x T - W

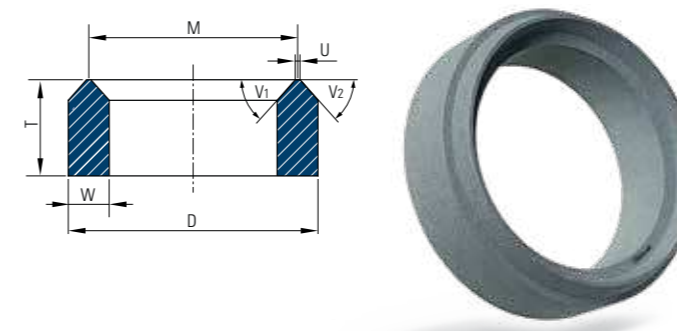

Customer additionally defines:

- tip diameter (M) according to drawing
- tip width (U) according to drawing
- angles (V<sub>1</sub> & V<sub>2</sub>)

Example: 2Z - 330 x 89 - W30,5

## RACK GRINDING

Wheels for Gear Rack grinding can be made for Creep-Feed process or for regular grinding operations. They can be made blank or pre-profiled. Suitable for machine brands like Habrama, Schneeberger, Kesel, etc.

1ZR - D x T x H - M.. V..

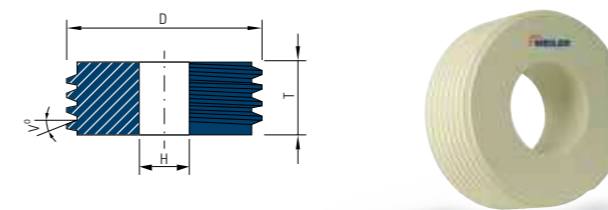

Customer additionally defines:

- tip diameter (M) according to drawing
- tip width (U) according to drawing
- angles (V<sub>1</sub> & V<sub>2</sub>)

Example: 1ZR 400x100x152,4 - M..



# SHARPENING

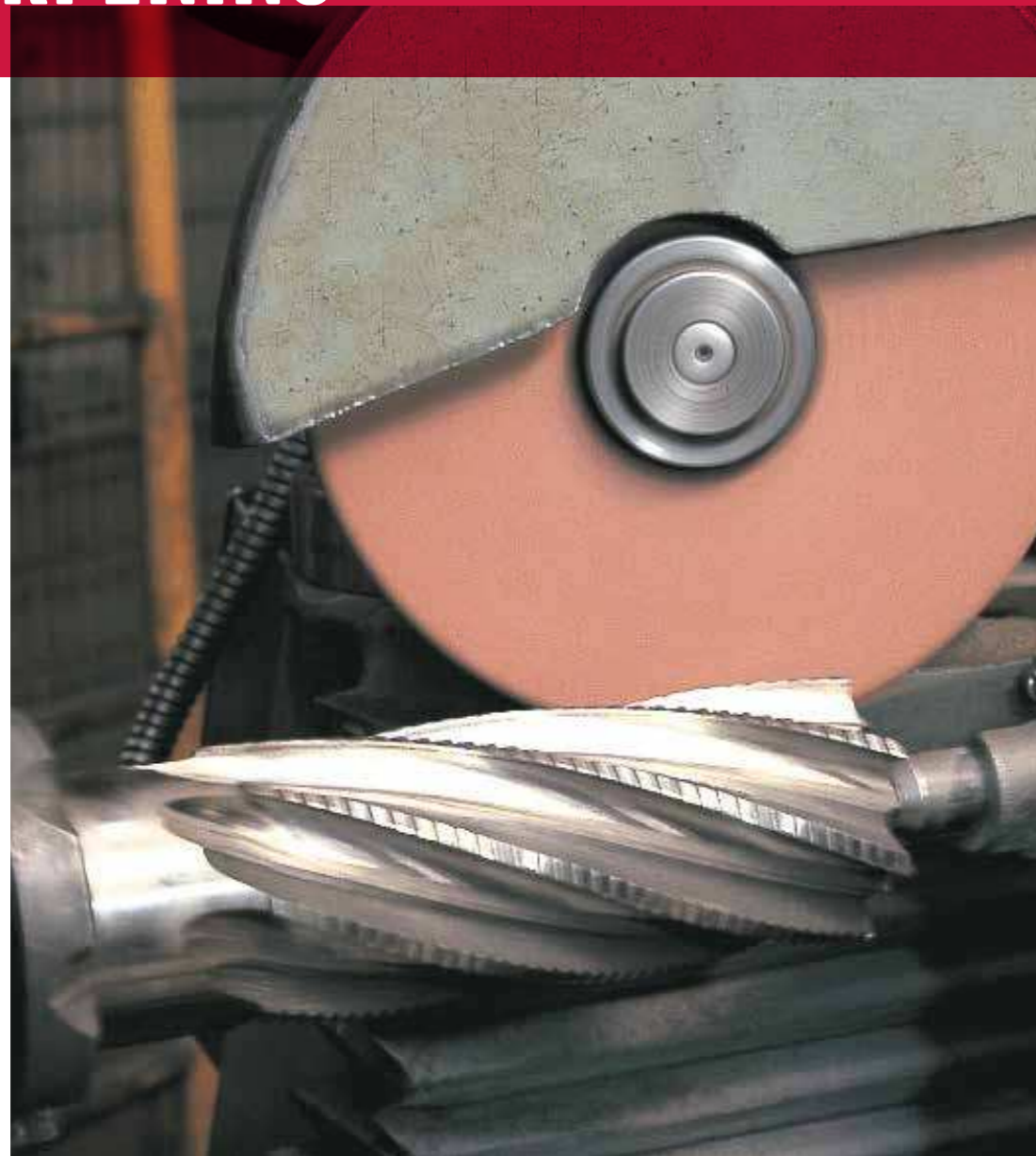

## BAND SAW SHARPENING

**Grinding wheel 12G**  
D x T x H

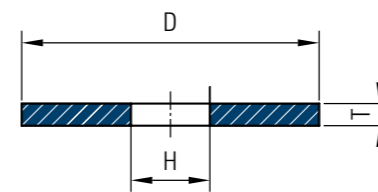

## RAPTOR

D	T	H
200	6 to 14	20 to 40
250	6 to 14	20 to 40
300	8 to 22	20 to 76,2
350	8 to 22	20 to 127
400	10 to 16	20 to 127

### ADVANTAGES:

- excellent profile retention
- high cutting capacity
- no need for deburring
- repeatable high efficiency
- highest number of ground grinding teeth
- smooth and calm operation

### APPLICATIONS:

For use on the following grinding machines:  
Vollmer, Iseli, Alix, Shark, Armstrong, etc.

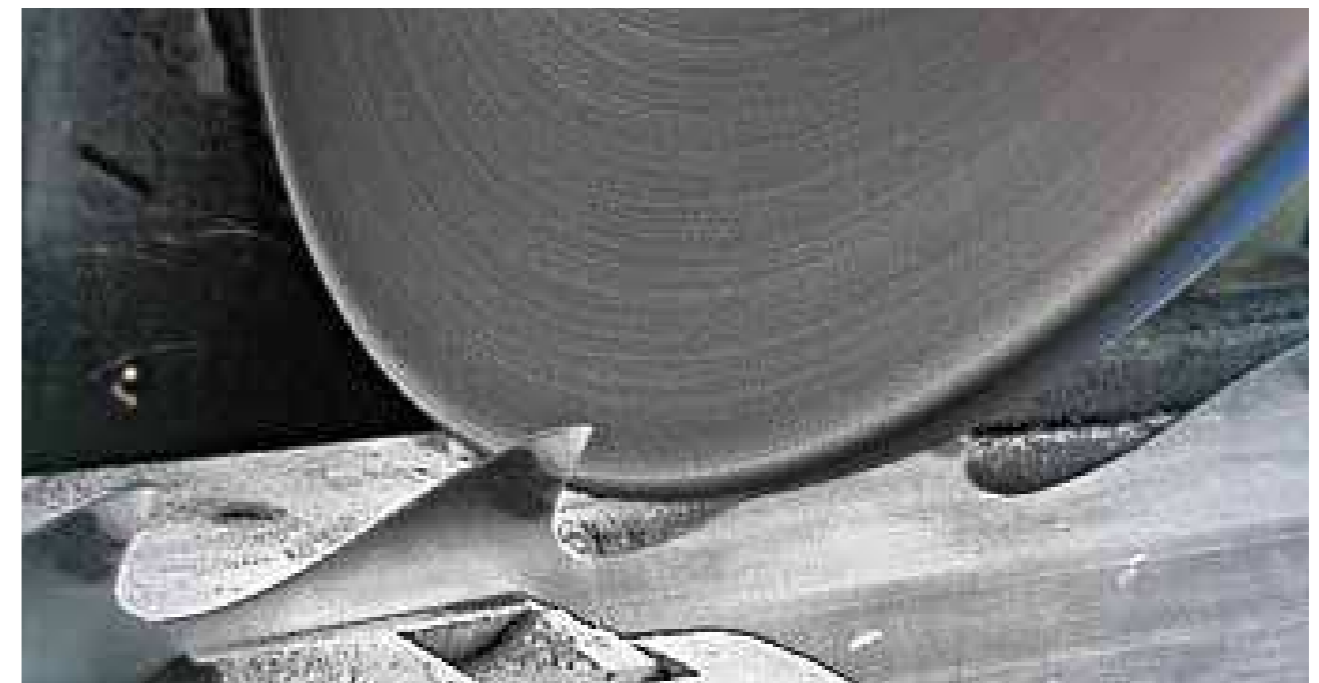

# SAW SHARPENING

## Grinding wheel 1

D x T x H

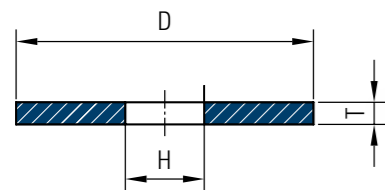

D	T	H
80	0,8 to 13	10, 13
100	1 to 20	13, 20
125	1 to 20	20
150	1 to 20	20, 32
175	1,5 to 20	20, 32
200	1,5 to 20	20, 32
250	1,5 to 20	20, 32, 50.8

## Grinding wheel 1- ..

D x T x H

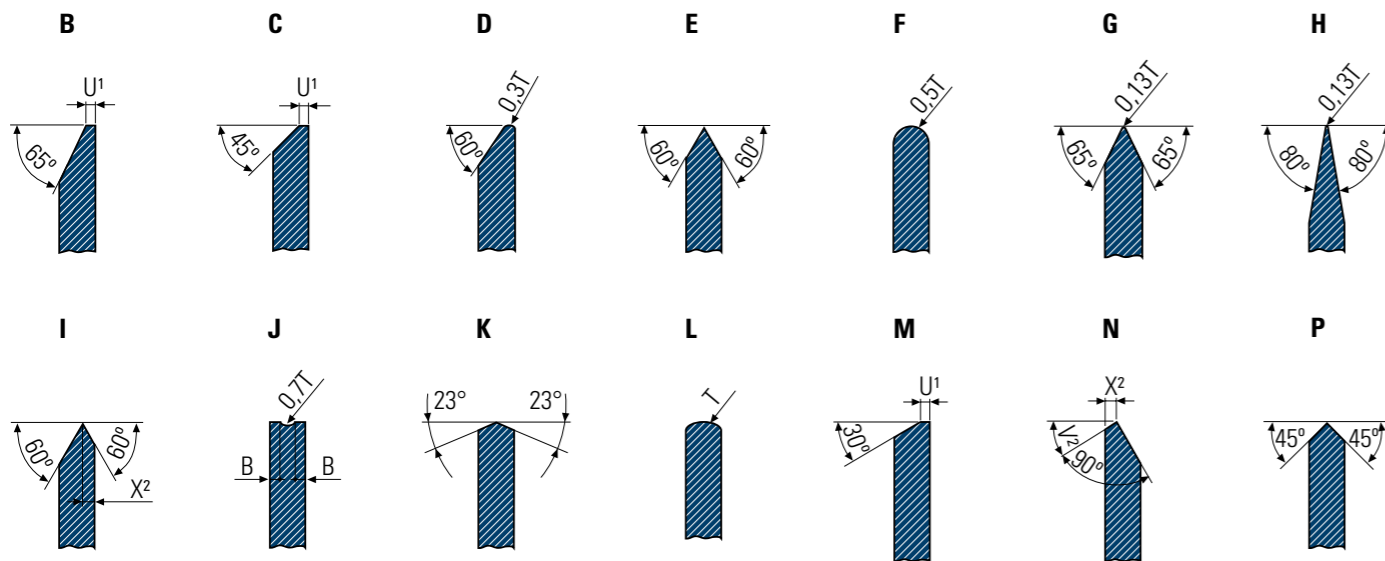

D	T	H
100	1 to 4	10, 13, 20
125	1 to 5	16, 20
150	2 to 13	20
175	2 to 13	20
200	2 to 16	20, 32
225	2,5 to 16	20, 32
250	4 to 20	20, 32
300	6 to 25	32, 40

Products of other dimensions can be made to special order.

# CUTTING TOOL SHARPENING

## Grinding wheel 12

D / J x T / U x H - W x E x K

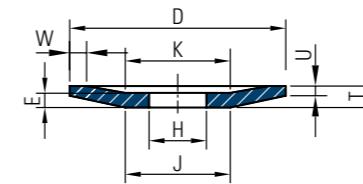

D	J	T	U	H	W	E	K
50	25	10	2	13	4	6	25
80	31	10	2.5	13	4	6	31
100	36	13	3.2	20	5	7	36
125	61	13	3.2	20	6	7	61
150	66	16	3.2	20	8	9	66
175	78	18	3.2	20	9	10	78
200	90	20	3.2	20, 32	10	10	90
250	140	22	4	32	12	12	140

## Grinding cup 6

D x T x H - W x E

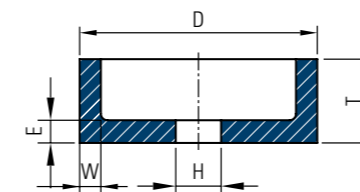

D	T	H	W	E
50	32	13	5	8
80	40	20	6	10
100	50	20	8	10
125	63	20	8	13
150	80	20	10	16
175	100	32	15	20
200	100	32	20	25
250	100	76	20	25

## Grinding cup 11

D / J x T x H - W x E x K

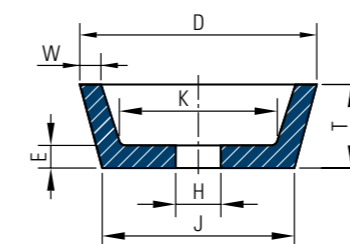





D	J	T	H	W	E	K
50	27	32	13	4	8	22
80	57	32	13	6	8	46
100	71	40	20	8	10	56
125	96	40	20	10	10	81
150	114	45	20	10	13	96
175	135	45	32	12,5	15	120
200	155	50	32	20	20	140
250	200	60	76	30	20	180

Products of other dimensions can be made to special order.

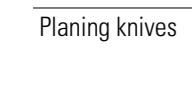

## GENERAL RECOMMENDATIONS

Work piece	Manual grinding	Mechanical grinding		
 Turning cutters	Tool steel	2A60K7V	2A60J8V, 3GA60J8V	
	High-speed steel (HSS)	4A60K7V	62A60J8V, 3GA60J8V	
	Tungsten carbides	C60K6V	C60K6V	
 Spiral drills	<b>Profiling</b>		<b>Sharpening</b>	
	Tool steel	2A60M8V	2A100L8V, 3RA120I6V	
	High-speed steel (HSS)	82A60J6V	2A100L8V, 3RA120I6V	
 Cutters, drills	<b>Profiling</b>		<b>Sharpening</b>	
	Tool steel	82A46/3J6V, 82A100I8V	2A46/1H9/0V, 22A46H10/0V	
	High-speed steel (HSS)	82A46/3J6V, 82A100I8V	2A46/1H9/0V, 22A46H10/0V	
 Pull and push broaches	High-speed steel (HSS)	3GA70/3K5V		
	 Planing knives	<b>Profiling</b>		<b>Sharpening</b>
Wood working		2A30/1J7V, 42A46G8B	2A80I12/2SV, 42A60G8B	
 Saw sharpening	<b>Profiling</b>		<b>Sharpening</b>	<b>Grinding of tooth flank</b>
	Circular saws (HSS) - tool steel	A60/3L7V, 2A46/3M6V, 3GA46/2K5V12R2, 40A60N/22A60L5V	3GA60/3M6V, 4A46/3M6V	4A60M7VR, 2A60K7V
	Circular saws (Stellite)	A60/3M7V	2A60/3L7V13	4A60M7VR, 2A60K7V
	Band saws (HSS)	3GA60/3N5V, 2A46/3M5V	3GA60/3N5V, 2A46/3M5V	
	Band saws (Stellite)	4A46M/22A46K5V	2A60/3K7V	4A60M7VR, 2A60K7V
	Chain saws (HSS)	4A60M6V		
	Band-block saw (HSS)	3GA46/3O5V, 2A46/3N5VL	3GA60/3O5VR, 2A46/3N5V	4A60M7VR, 2A60K7V

## BENCH AND TOOLROOM GRINDING WHEELS

### Grinding wheel 1

D x T x H

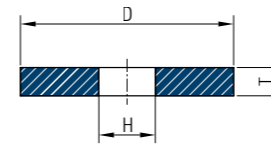

D	T	H	
125	20	12.7, 16, 20, 25, 32, 40	W*
150	20	12.7, 16, 20, 25, 32, 40	W*
175	20	16, 20, 25, 32, 40	W*
200	20, 25	16, 20, 25, 32, 40	W*
250	20, 25	16, 20, 25, 32, 40	W*
300	30, 40	30, 40	
350	40	30, 40	
400	40, 50	40	

W\* - R16 includes reducer rings 12.7, 16, 20, 25, 32



# SURFACE GRINDING & CREEP FEED



## SURFACE GRINDING

### Grinding wheel 1

D x T x H

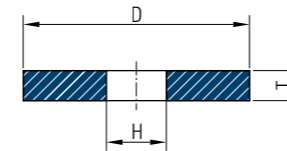

### Grinding wheel 5

D x T x H - P x F

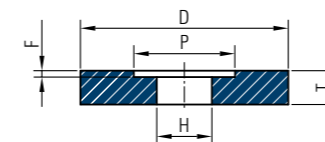

### Grinding wheel 7

D x T x H - P x F / G

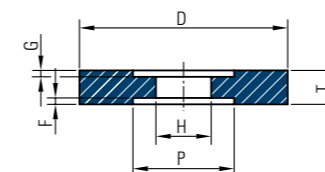

D	T	H
100	10 - 102	10, 13, 16, 20, 25, 32
125	10 - 102	13, 16, 20, 25, 32, 40
150	10 - 152	13, 16, 20, 25, 32, 40
200	10 - 152	13, 16, 20, 25, 32, 40, 51
225	10 - 152	16, 20, 25, 32, 40, 50, 60
250	10 - 152	20, 25, 32, 40, 51, 76
300	10 - 152	32, 40, 51, 76, 127
350	10 - 152	32, 40, 51, 76, 127, 152.4
400	10 - 203	40, 51, 76, 127, 152.4, 203
450	10 - 254	76, 127, 152.4, 203, 254, 305
500	20 - 254	127, 152.4, 203, 254, 305
600	20 - 254	127, 152.4, 203, 305



## GENERAL RECOMMENDATIONS

Application:	Quality class/Specification	
	STANDARD	EXTRA
<b>Universal - multipurpose:</b>		
Non-hardened steel:	2A46JV	3GA46J6V
Hardened steel:	82A46H12V	3GA46H12V
<b>Special grinding</b>		
Non-hardened steel (steel for automatic machines and structural steel):	2A46H8V	
Hardened steel (low-alloy, up to 60 HRc) - Quenched and tempered steels	2A46H12V, 82A46H12V	3GA60G12V
<b>Hardened steel (high-alloy, over 62 HRc)</b>		
- Tool steels	82A46H12V	3GA60F12V, B126M6VR
- High-speed steels (HSS)	8A60F12V, 18GA60F12V	3GA46F12V
<b>Stainless steel (INOX):</b>		
- Non-hardened steel	4A60H12V, C60H12V	
- Hardened steel	84A60G12V	
<b>Nitriding steels:</b>		
- Not thermally treated steels - core	82A46H8V	
- Nitriding	C60H12V, C60F12V (>62HRc)	
<b>Casting:</b>		
- Steel cast iron	82A60H12V	
- Gray cast iron	C60H12V	
- Timed and nodular iron	82A60H12V	
<b>Tingsten carbides (HM) and ceramic:</b>	C60H12V	
<b>Non-metals and non-ferrous metals:</b>		
- aluminium, copper, bronze,...	2A46J8V, C46H12V	
- Rubber	2A36G12V, 1A24J7V	



# SHARPIO - NEW INNOVATIVE BONDING SYSTEM TURBINE BLADES

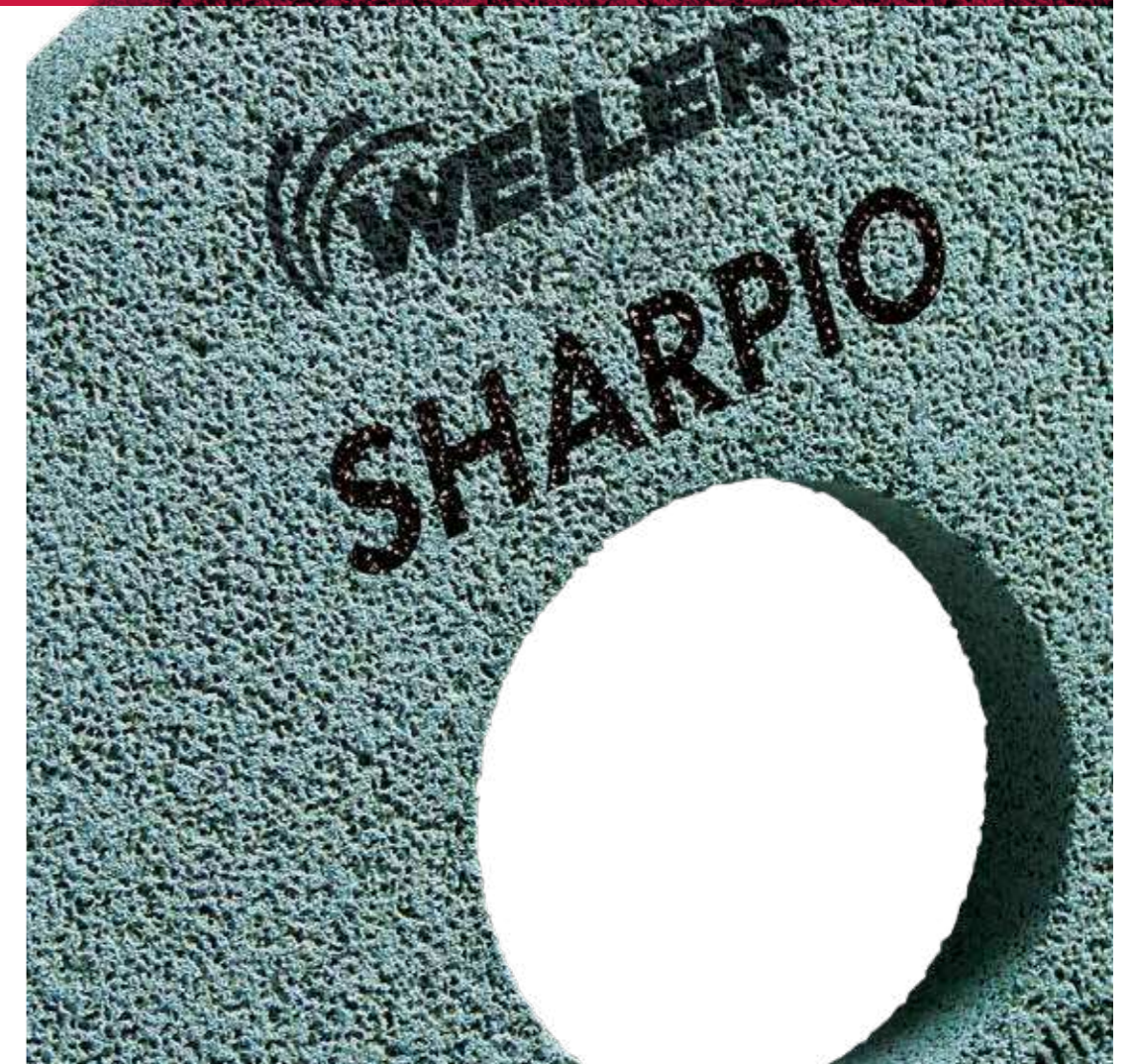

## SHARPIO - INNOVATIVE BONDING SYSTEM

Efficient grinding of hard-to-grind materials with a new composition and innovative bonding system.

SHARPIO is a new product for surface and creep feed of hard materials, such as alloy elements in steel CrMoV. A new bonding system combined with a special composition formula greatly enhance grinding efficiency.

### APPLICATIONS:

Weiler SHARPIO bonding system offers new solution for grinding wide range of applications:

- turbine blades (jet and gas turbine components),
- gears,
- bearings,
- saw sharpening,
- toolroom.

### ADVANTAGES:

- large material removal rates on hard materials
- increased productivity
- lower grinding forces
- higher G-factor ( $G = V_w / V_s$ )
- self-sharpening effect
- lower grinding temperature
- short delivery times for standardized shapes

Higher G factor

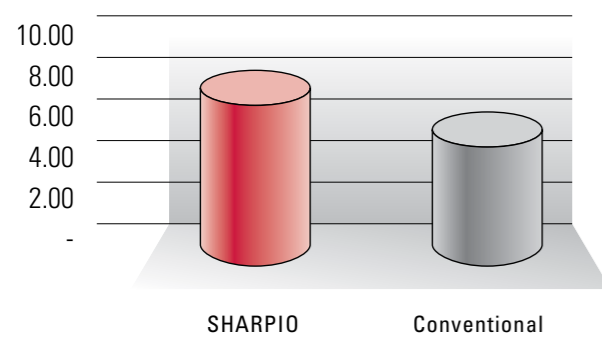

Lower grinding FORCE (N)

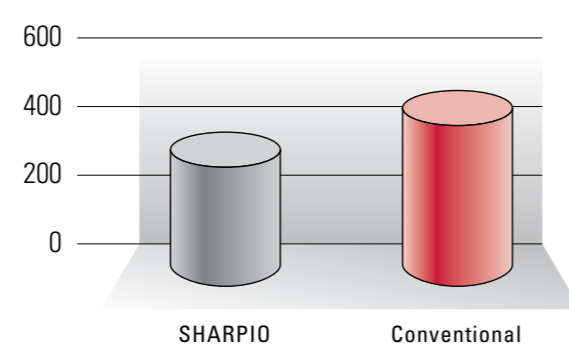

## SURFACE GRINDING WITH GRINDING SEGMENTS

### GRINDING SEGMENT TYPES

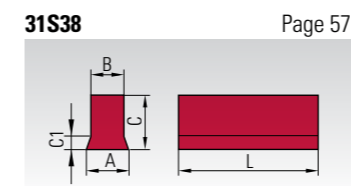
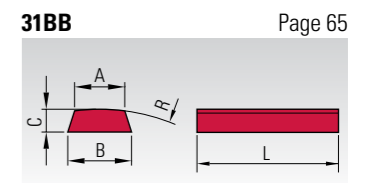
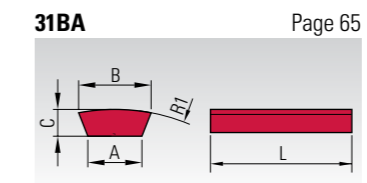
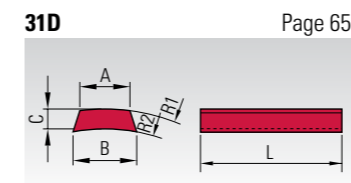
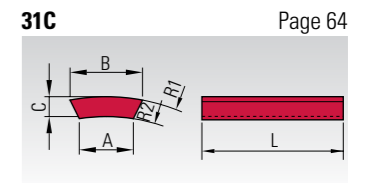
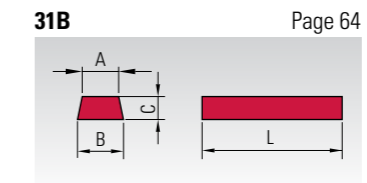
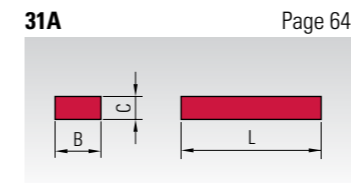

## SURFACE GRINDING WITH RINGS AND CUPS

Grinding ring 2

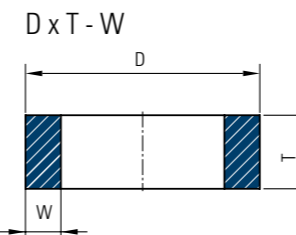

Grinding cup 6

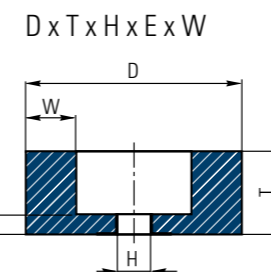

D	T	H
100	90	10
125	80	32
150	90	15
175	90	20
200	90	20
250	100	25
300	120	32
350	125	40
400	125	40



## GENERAL RECOMMENDATIONS

Application:	Specification	
	Type 2, 6	Type 31..
<b>Universal - multipurpose:</b>		
Non-hardened steel	2A46H8V	2A24J7V
Hardened steel:	82A46H12V	2A46H12V
<b>Special grinding:</b>		
Non-hardened steel (structural steel):	2A46H8V	2A24H7V, 3GA46F12V
Hardened steel (alloy up to 60 HRc) - Tempered steels	2A46H12V, 82A46H12V	2A36H8V
<b>Hardened steels (high alloy over 62 HRc)</b>		
- Tool steel	82A46H12V	4A36E12V, 3GA36F12V
- High-speed steels (HSS)	8A60F12V, 18GA60F12V	
<b>Stainless steel (INOX):</b>		
- Non-hardened	4A60H12V, C60H12V	2A24H7V
- Hardened	84A60G12V	2A36G8V
<b>Nitriding steels:</b>		
- Not thermally treated - core	4A46H8V	2A24H7V
<b>Casting:</b>		
- Steel cast iron	82A46H12V	2A24H7V
- Gray cast iron	8246H12V	C36H9V, 42A36H11V
- Timed and nodular iron	C46H12V	C46H12V
<b>Carbide alloy (HM)</b>	C46H12V	C60H6V
<b>Ceramic:</b>	C46H8V	C36H7V
<b>Non-metals and non-ferrous metals:</b>		
- aluminium, copper	C46H8V	C36H12V
<b>Band saws (form 6)</b>	2A80M8VR1	



# GRINDING WHEELS FOR BEARING INDUSTRY



Efficient grinding for special requirements in Bearing Industry

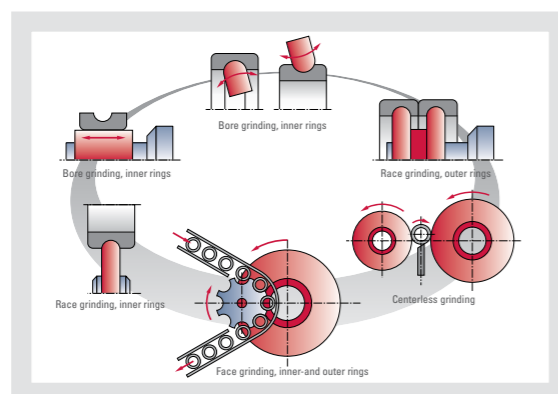

## CENTERLESS GRINDING OF OUTER RINGS

- excellent performance /price ratio
- enables the achievement of strict tolerances of ovality, waviness and parallelism
- high stability, good profile retention
- better productivity
- thickness is not limited as the composition of the final product can be made of x-parts and therefore we can achieve better stability of the process

Shapes	Specification	Dimensions (mm)			Working speed (m/s)
		D	T	H	
1, 5, 7	42A	350 - 650	125 - 612	305	35 - 50
	772A	depending on the machine			

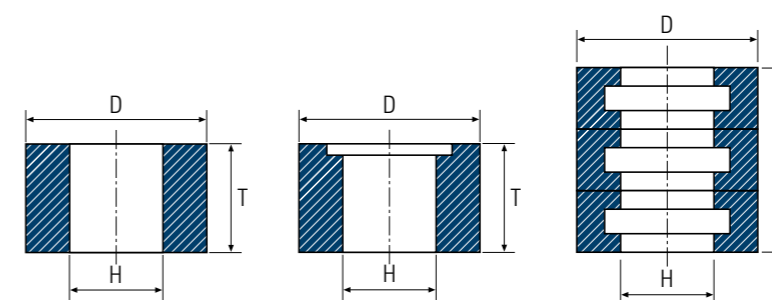



## FACE GRINDING OF INNER AND OUTER RINGS

- enables good surface quality, parallelism and final form
- better productivity- higher output
- less dressing



Shapes	Specification	Dimensions (mm)	Working speed (m/s)
36, 36Z 36P, 37	STANDARD	According ISO 525	25 - 40
	HIGH PERFORMANCE		

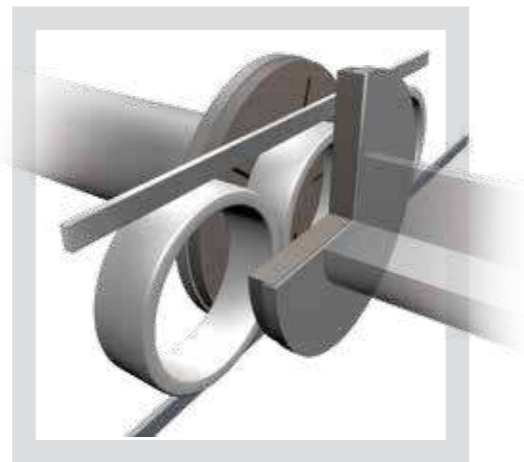

D	T	H
457	75	???
600	75	????
900	????	???

## BORE GRINDING

- better profile retention, achieved good surface quality
- for higher productivity, shorter grinding time

Shapes	Specification	Dimensions (mm)		
		D	T	H
1, 5	STANDARD	6 - 100	10 - 40	on demand
	HIGH PERFORMANCE			

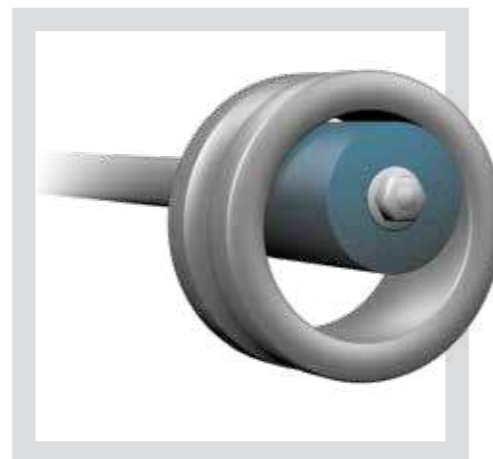
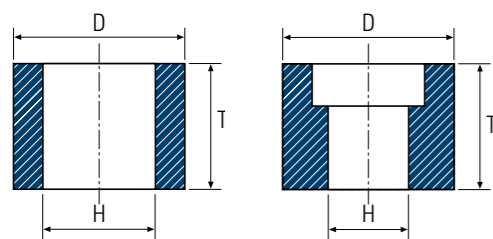

## RACEWAY GRINDING OF INNER AND OUTER RINGS

- working speed up to 125m/s
- enables the achievement of strict tolerances of required parameters
- good profile retention
- higher productivity, less dressing

Shapes	Specification	Dimensions (mm)	Working speed (m/s)
1LT, 1-F, 1-R, 1-N, 1Y12, 3Y3, 38, 39	STANDARD	by customer requirements	50 - 125
	HIGH PERFORMANCE		

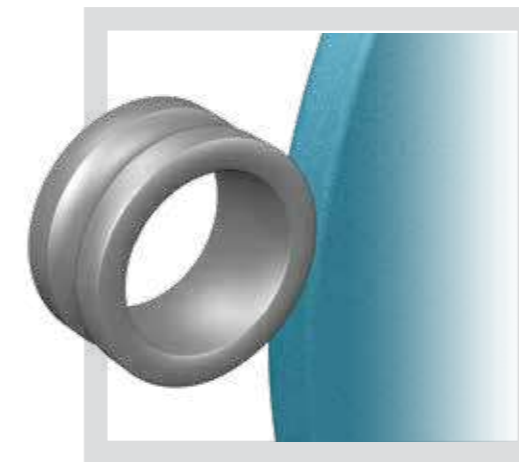
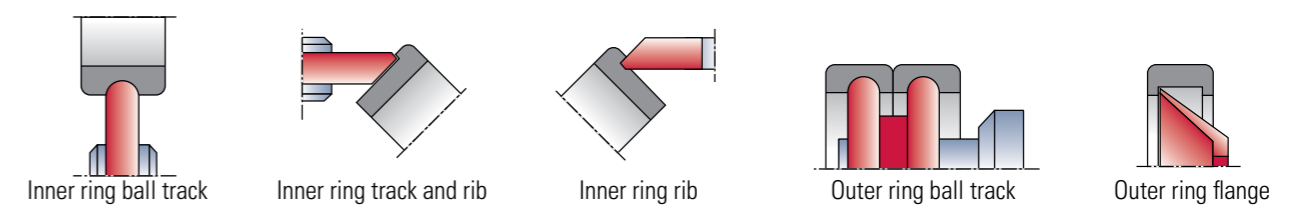

# CYLINDRICAL GRINDING

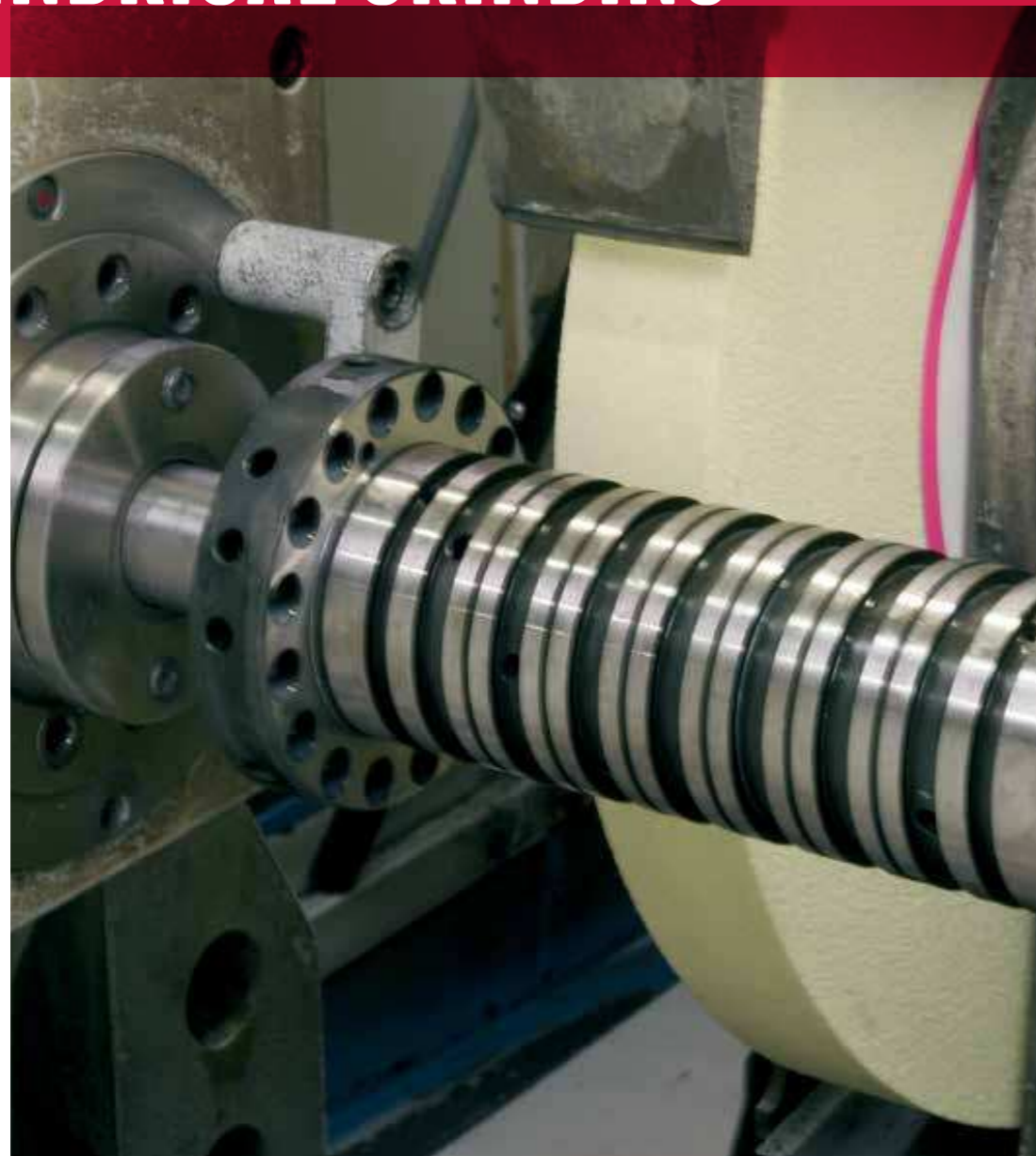

## CYLINDRICAL GRINDING

**Grinding wheel 1**

D x T x H

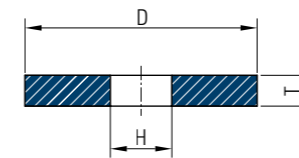

D	T	H
100	10 to 32	10, 13, 16, 20, 25, 32
125		13, 16, 20, 25, 32, 40
150		13, 16, 20, 25, 32, 40
200		13, 16, 20, 25, 32, 40, 50.8
225		16, 20, 25, 32, 40, 50.8, 60
250		20, 25, 32, 40, 50.8, 76.2
300	10 to 50	32, 40, 50.8, 76.2, 127
350	16 to 50	32, 40, 50.8, 76.2, 127, 152.4
400	20 to 80	40, 50.8, 76.2, 127, 152.4, 203.2
450		76.2, 127, 152.4, 203.2
500	25 to 100	76, 127, 152.4, 203.2
600	32 to 100	152.4, 203.2, 304.8
750	32 to 125	304.8
800		304.8
900		304.8
1060	32 to 160	304.8
1250		304.8

**Grinding wheel 5**

D x T x H - P x F

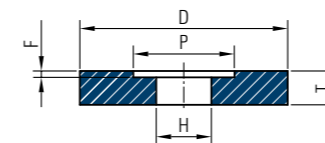

D	T	H	P	F
100	10 to 32	25, 32, 40	60	
125		25, 32, 40, 50.8	75	
150		25, 32, 40, 50.8		
200	20 to 40	25, 32, 40, 50.8	110	
225		25, 32, 40, 50.8		
250		40, 50.8, 76.2	130	
300	32 to 80	76.2, 127	190	
350	40 to 80	76.2, 127	215	
400		127		
450	40 to 100	127	215	
		203.2	290	
500	40 to 160	203.2	290	
		304.8	390	
600		203.2	290	
		304.8	390	
750	63, 80, 100, 125	304.8	410	
900				
1000				
1060				
1250				

max. T/2

Products of other dimensions can be made to special order.



# INTERNAL GRINDING

## Grinding wheel 1

D x T x H

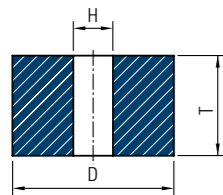

D	T	H
6	6, 10, 13	2,5 3
8	8, 10, 16	2,5 3
10	6, 10, 13, 20	3, 4
13	6, 13, 20	3, 6
16	6, 10, 16	6,
20	13, 20, 25, 32	6, 8
25	13, 20, 25, 32, 40	6, 8, 10
32	13, 20, 25, 32, 40	6, 8, 10, 13
40	13, 20, 25, 32, 40	6, 10, 13, 16
50	13, 20, 25, 32, 40	10, 13, 16, 20
63	13, 20, 25, 32, 40	13, 16, 20
80	13, 20, 25, 32, 40	16, 20, 25
100	16, 25, 32, 40, 50	16, 20, 25

## Grinding wheel 5

D x T x H - P x F

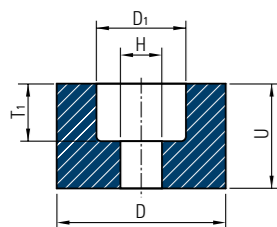

D	T	H	P	F
16	10, 16	6	10	max. T/2
20	13, 20	6, 8	13	
25	10, 16, 25	6, 8, 10	16	
32	16, 20, 25, 32	8, 10, 13	20	
40	20, 25, 32, 40	10, 13	25	
50	20, 25, 32, 40	16, 20	32	
63	25, 32, 40, 50	16, 20	32	
80	40, 50, 63	20, 25	40	
100	32, 40, 50	20, 25, 32	52	

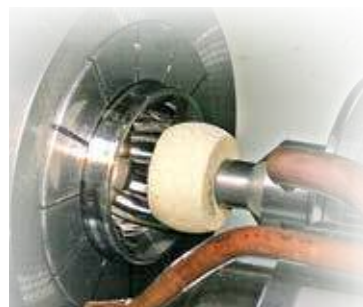

Products of other dimensions can be made to special order.

# GENERAL RECOMMENDATIONS

	Applications	Quality class/Specification	
		STANDARD	EXTRA CBD
Steel	Universal	3LA80JKV	
	Non-hardened steel:	4A60KV	
	Hardened up to 62 HRc	2A60JV, GA60JV	B126V
	Hardened over 62 HRc	3LA80JKV, 3GA60KV, 8A60IV	B126V
	High-speed steels (HSS)	62A8JV	B126V
	Stainless steel	2A60JV	
	Bearings	82A80KLV, 82A100KV	B107V
	Hard metals	Tungsten carbides	C80IV
Non-ferrous metals	Al, Cu	C 60JV	
Castings:	Gray, ductile	3A200B12, 53C24QB	
Non-hardened steel	Plastic materials	C60V	

# RAILWAY GRINDING AND CUTTING WHEELS



In the production and maintenance of tracks, various types of grinding tools are used, depending on the place and the grinding method.

These grinding wheels are intended for the maintenance of railway tracks as well as for grinding of welds and railway switchpoints on machines intended specifically for this purpose.

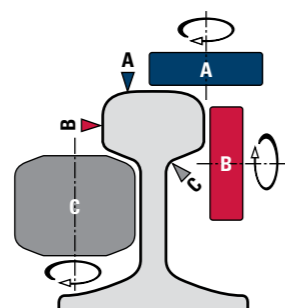

Zone A - railway track head  
 Zone B - railway track lateral edge  
 Zone C - web

## GRINDING OF RAILWAY TRACKS

### Grinding wheels 1A

For railway track grinding - zone B  
 D x T x H

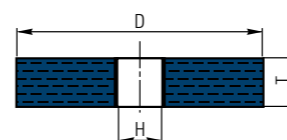

Type	D	T	H
1A	230	20	22,23
1A	230	23	22,23
1A	230	25	22,23
1A	250	20	25,4
1A	250	25	25,4
1A	260	25	120

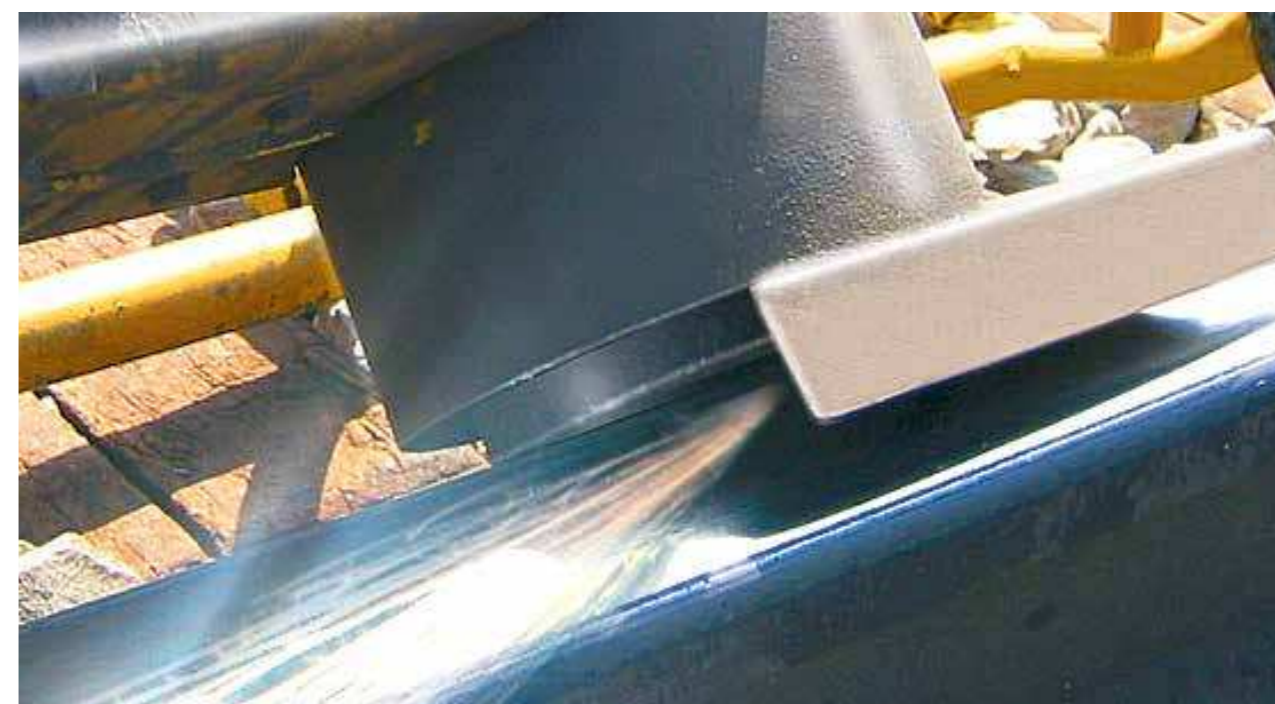

### Grinding wheels 5A and 7A0

For grinding of welds zone B  
 D x T x H - P x F

#### 5A

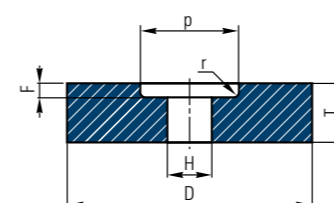

Type	D	T	H	P x F
5A	254	20	25,4	150 x 8
5A	254	25	25,4	150 x 19
5A	255	32	25,4	153 x 12
7A0	250	40	76,2	166 x 10/10



### Grinding cup 6

for grinding of welds zone A  
D x T x H x W x E

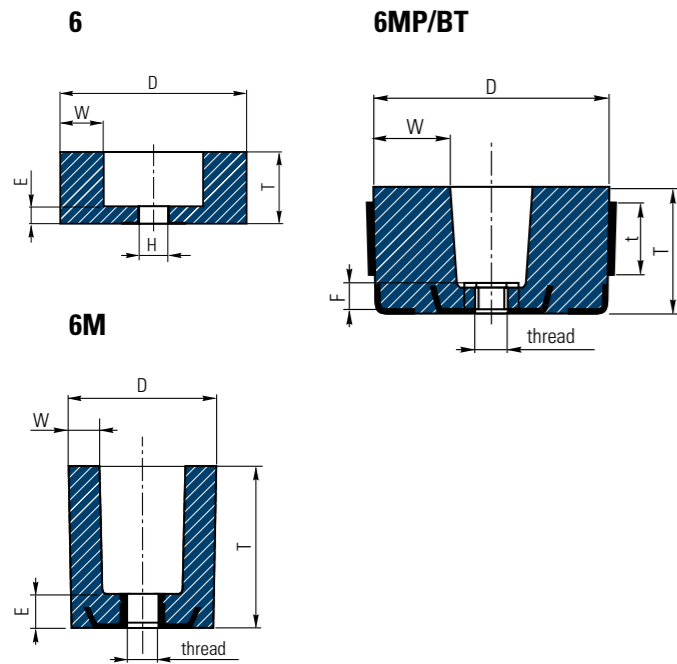

Type	D	T	H	W	E
6	100	110	22M	20	20
6M	100	110	M20L	20	23
6M	100	110	M20L	25	23
6M	125	65	M20	37	12
6M	125	90	M20	25	23
6MP/BT	152	80	U5/8"	49,5	20
6MP/BT	152	80	M20	51	20

### Grinding segment 31S..

For grinding of welds zone A  
B/A x C x L

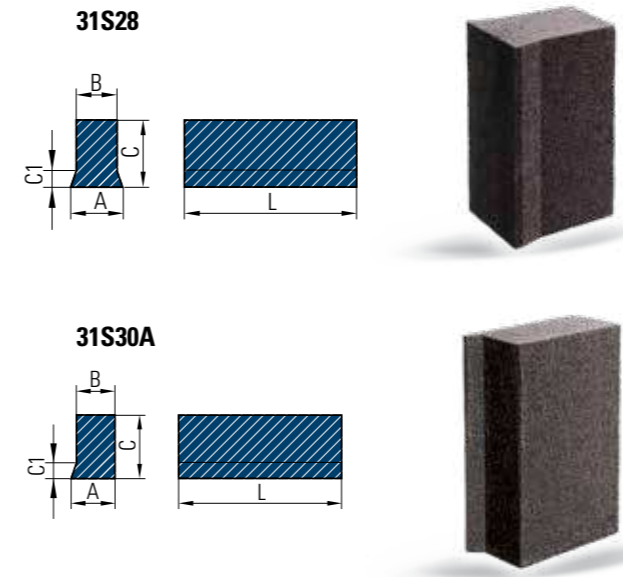

Type	B/A	C	L
31S28A	60/69	90	158
31S30A	166/55	75	248

### Grinding cup 11

For grinding of railway track weld profile  
D/J x T x H x W

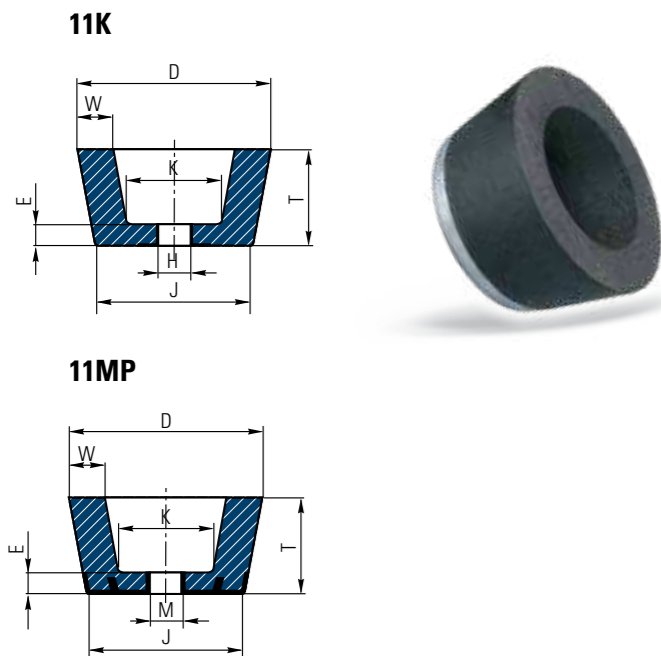

Type	D/J	T	H	W
11K	110/90	55	22,23	20
11MP	110/90	55	M14	20

### APPLICATIONS:

Manual grinding with an angle grinder (phy 180 mm) in places where machine grinding is not possible due to lack of access.

### Grinding ring 35

For grinding of welds zones A and B  
D x T x H x E x W

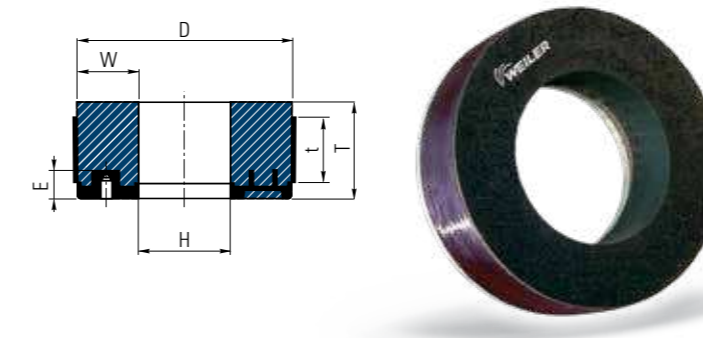

Type	D	T	H
35L/BT	260	82	154
350	260	35	195
35/BT	180	105	90
350	280	32	210

### Grinding wheels 7Y2

For grinding of zone C  
D x T x H - P x F



Type	D	T	H	P	F
7Y2	135	95	25,4	55	30/30

### APPLICATIONS:

Grinding of connecting chambers with machines intended specifically for this purpose.

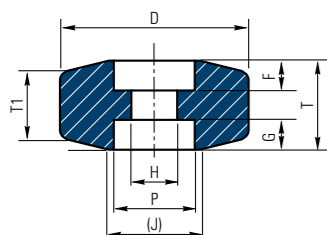

### Grinding wheels 36

for grinding of welds zone A  
D x T x H

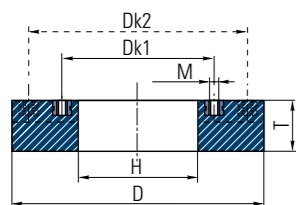

Type	D	T	H
36/2	125	60	55-4/M8-15A
36/3	150	79	80-6/M8-20A
36/5	150	75	55-4/M8-15A

## RAILWAY CUTTING-OFF

### Cutting-off wheels 41

D x T x H

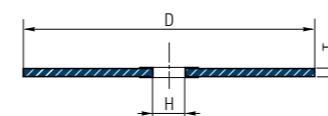

### MAX RAIL

Fast cut and long life on rail.

Dimensions D x T x H mm	Grade	Reinforcement	Speed m/s	Max. RPM min <sup>-1</sup>	F41 Standard Pack
356 x 4 x 20	E74A20R-BF	3x	100	5500	10
356 x 4 x 22,23					
356 x 4 x 25,4					
406 x 4 x 20				4800	
406 x 4 x 22,23					
406 x 4 x 25,4					



388395

### PRO RAIL

Fast cut on rail.

Dimensions D x T x H mm	Grade	Reinforcement	Speed m/s	Max. RPM min <sup>-1</sup>	F41 Standard Pack
356 x 4 x 20	45A24Q-BF	3x	100	5500	10
356 x 4 x 22,23					
356 x 4 x 25,4					
406 x 4 x 20				4800	
406 x 4 x 22,23					
406 x 4 x 25,4					



388393





# PRODUCT INFORMATION MANAGER

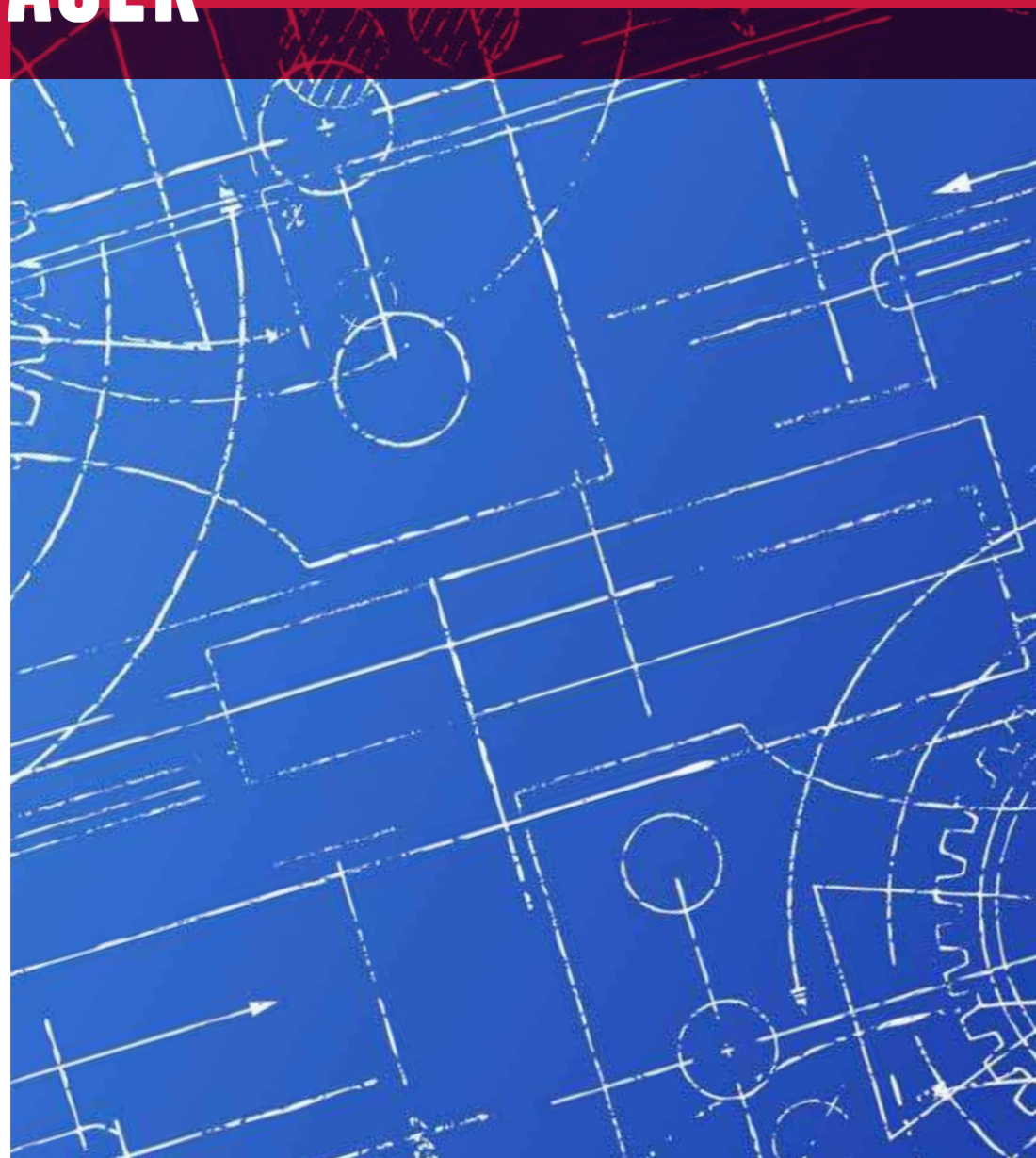

## SPECIFICATION AND PROPERTIES OF GRINDING TOOLS

42A	120/9		H		7/5			V	R12L	63 m/s
Grain type and combination	Grit size and grit size combinations		Hardness		Structure / Porosity			Bond	Internal designation	Maximum operating speed
1A	8	Coarse	D	Soft	1	Closed	1	V - Vitrified B - Resin BF - Fibre-reinforced resin	R - Laterally reinforced E - Unilaterally surface reinforced D - Bilaterally surface reinforced W - Impregnated	
3A	10		E		2		2			
A	12		F		3		3			
2A	14		G		4		4			
	16		H		5		5			
	20		I		6					
	24		J		7					
	30		K		8					
7A	36		L		9					
4A	40		M		10					
6A	46		N		11					
PA	54		O		12					
	60		P		13					
8A	70		Q		14					
GA	80		R		15					
LA	90		S		16					
9C	100		T	Hard	17					
C	120				18					
	150				19					
ZA	180				20	Open				
	220									
	240									
	280									
	320									
	360									
	400									
	500									
	600									
	800	Fine								

# GRINDING WHEEL TYPES

(according to ISO 525)

**1**

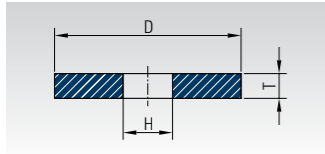

**1A**

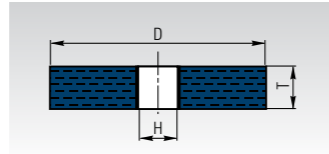

**1VS, 1FK**

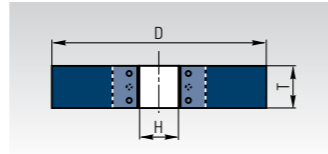

**20**

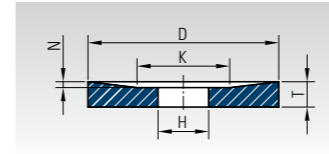

**21**

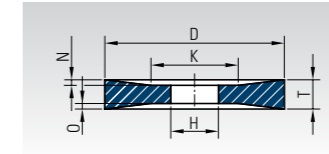

**21P**

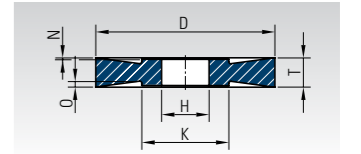

**1Z**

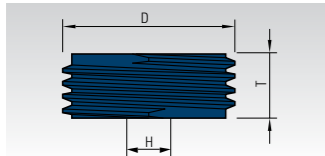

**1A1**

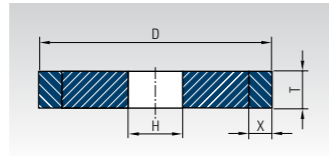

**1A8, 1 NA**

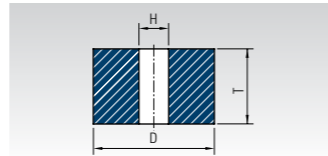

**22**

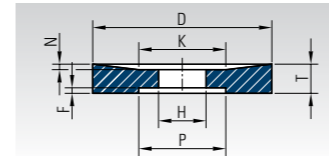

**23**

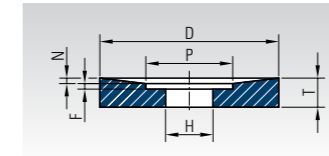

**24**

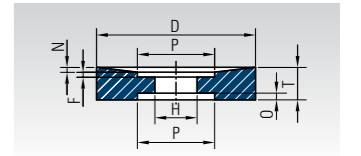

**1A8, 5NB**

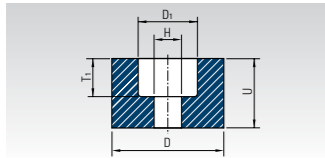

**2**

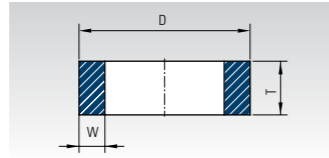

**3, 3K1**

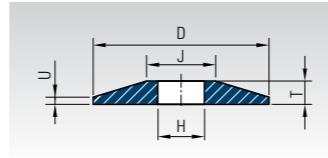

**25**

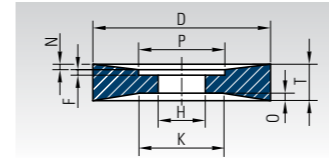

**26**

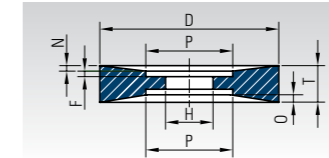

**27**

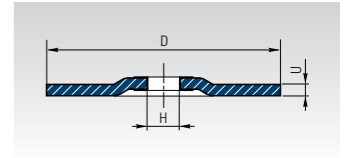

Page 82

**3K, 3K2**

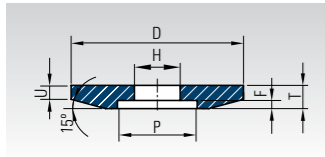

**4, 4N**

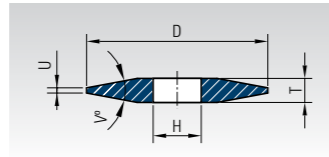

**5**

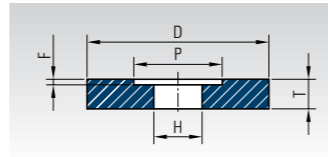

**28**

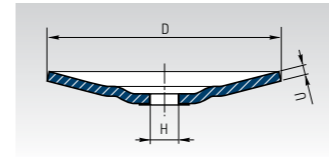

**35**

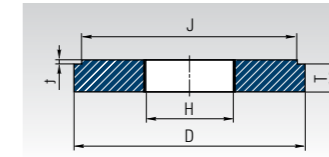

**36**

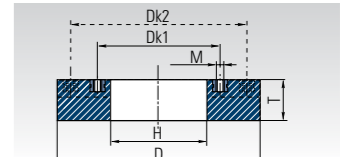

**6**

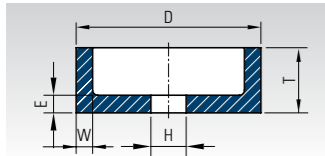

**7**

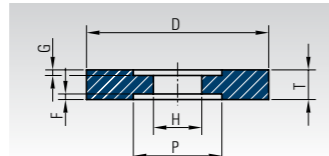

**7Y2**

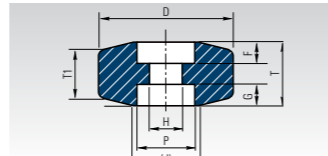

**36P**

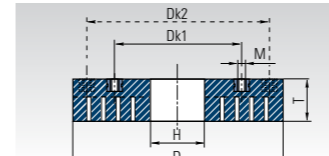

**37**

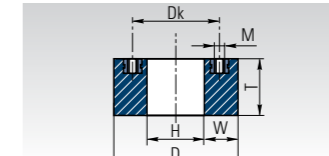

**38**

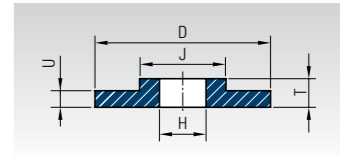

**9**

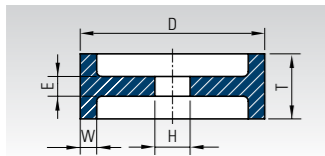

**11**

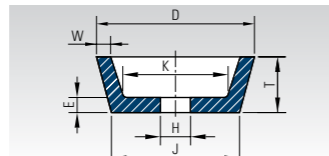

**12**

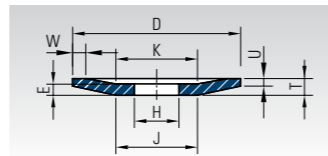

**39**

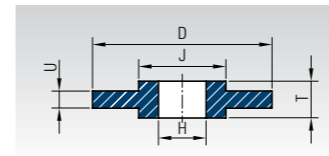

**41**

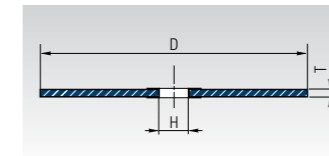

**42**

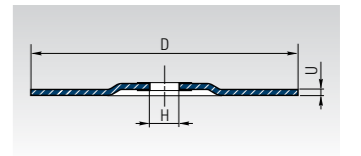

**12B**

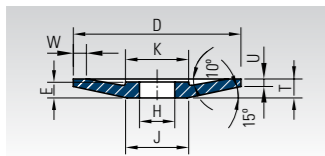

**12BH**

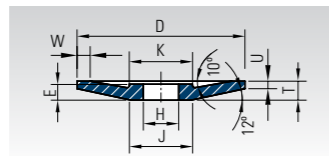

**12M**

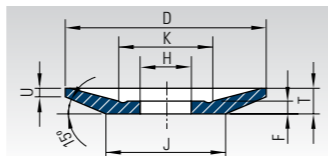



# STANDARD GRINDING WHEEL DIMENSIONS

in mm and inches

## DIAMETERS (D):

	D/mm	inches
*	3	1/8
*	4	5/32
*	5	3/16
*	6	1/4
*	8	5/16
*	10	3/8
*	13	1/2
*	16	5/8
*	20	3/4
*	25	1
	30	13/16
*	32	1 1/4
*	40	1 1/2
*	50	2
	51	
*	63	2 1/2
	75	3
	76	
*	80	3 1/4
	82	
*	100	4
	102	
*	115	4 1/2
*	125	5
	127	
*	150	6
	152	
*	175	7
	178	
*	180	
*	200	8
	203	

	D/mm	inches
*	225	9
*	230	
*	250	10
	254	
*	300	12
	305	
*	350	14
	356	
*	400	16
	406	
*	450	18
	457	
*	500	20
	508	
*	600	24
	610	
	650	26
	660	
	700	28
	710	
*	750	30
	762	
*	800	32
	813	
*	900	36
	914	
*	1000	40
	1016	
*	1060	42
	1067	
	1100	44
	1118	
*	1250	

## THICKNESSES (T):

	T/mm	inches
*	0.5	
*	0.6	
*	0.8	
	1	
*	1,2	3/64
*	1,6	1/16
*	2	5/64
*	2.5	3/32
	3	1/8
*	3,2	
	3,5	9/64
*	4	5/32
*	5	3/16
*	6	
	6,4	1/4
	7	
*	8	5/16
	9,5	3/8
*	10	
	12,7	1/2
*	13	
*	16	5/8
*	20	
	21	13/16
*	25	1
*	32	1 1/4

	T/mm	inches
	38	1 1/2
*	40	
*	50	
	51	2
*	63	
	64	2 1/2
	76	3
*	80	
*	100	
*	102	4
*	125	
	127	5
	150	
	152	6
*	160	
*	200	
	203	8
*	250	
**	254	10
	300	
	305	12
*	315	
*	400	
	406	16
*	500	
	508	

## HOLE DIAMETERS (H):

	H/mm	inches
*	1,6	1/16
*	2,5	3/32
*	4	5/32
*	6	
	6.4	1/4
*	8	
	9,5	3/8
*	10	
	12.7	1/2
*	13	
	15,9	5/8
*	16	
	19,1	3/4
*	20	
*	22,2	7/8
*	25	
	25,4	1
	31,8	1 1/4
*	32	
	38,1	1 1/2
	40	
*	50,8	2
*	(51)	
	60	
*	(76)	
	76,2	3
*	80	
*	100	
*	127	5
*	152,4	6
*	160	
	(203)	
*	203,2	8
*	250	
	254	10
*	304,8	12
	(305)	
*	406.4	16
*	508	20

\*DIN standard 603-1 through 603-12

\* DIN standard 603-1 through 603-12

\*\* Grinding wheels with thicknesses of over 300 mm are composed of two or more parts.

# ABRASIVE GRAIN SIZE

Abrasive grain size complies with international standards and requirements. It is designated with numbers according to the FEPA standard. The number indicates the number of holes per inch length (25.4 mm) in a wire sieve that permits the grit to pass through. Macro grits have a granulation up to 200, and micro grits have a granulation of over 240.



Coarse grit is intended for coarse grinding, in which large material removal rates are required, while finer grit is intended for achieving smooth surfaces and for small material removal rates.

## CONVENTIONAL

FEPA	Dimensions (mm)	
8	2,83 - 2,00	Very
10	2,38 - 1,68	Coarse
12	2,00 - 1,41	
14	1,68 - 1,19	
16	1,41 - 1,00	Coarse
20	1,19 - 0,84	
24	0,84 - 0,60	
30	0,71 - 0,50	
36	0,60 - 0,50	
40	0,50 - 0,40	
46	0,40 - 0,30	Medium
54	0,35 - 0,25	
60	0,30 - 0,21	
70	0,25 - 0,18	
80	0,21 - 0,15	
90	0,18 - 0,13	Fine
100	0,150 - 0,110	
120	0,130 - 0,090	
150	0,110 - 0,060	
180	0,090 - 0,050	
220	0,075 - 0,045	
240	0,047 - 0,043	
280	0,038 - 0,035	
320	0,031 - 0,028	
400	0,018 - 0,016	
500	0,014 - 0,012	
600	0,010 - 0,008	
800	0,008 - 0,006	
1000	0,005 - 0,004	
1200	0,004 - 0,003	Very Fine

## SUPERABRASIVES - DIAMOND & CBN

	FEPA	ASTM E 11 70 (Mesh)	Dimensions (mm)
Coarse	427	40/50	0,425 - 0,300
	301	40/60	0,300 - 0,250
	252	40/80	0,250 - 0,180
Medium	181	80/100	0,180 - 0,150
	151	100/120	0,150 - 0,125
	126	120/140	0,125 - 01,06
	107	140/170	01,06 - 0,090
Fine	91	170/200	0,090 - 0,075
	76	200/230	0,075 - 0,063
	64	230/270	0,063 - 0,053
	54	270/325	0,053 - 0,045
	46	235/400	0,045 - 0,038

The abrasive granulation determines the grinding effect and the quality of machined surface. It is most cost-effective to select the coarsest granulation that still yields the required quality of machining.

	Coarse	Medium	Fine	Very Fine
STANDARD	20 - 36	46 - 80	90 - 220	240 - 600
SUPERABRASIVE	427 - 252	181 - 91	76 - 54	46

Large material removal rates

Good durability, fine surface

When higher material removal rates are required, a combination of coarse grinding and finishing is cost-effective. When a vitrified bonded grinding wheel with CBN and diamond grit is used instead of a conventional one, a considerably finer granulation has to be used to achieve the same surface quality (Al-oxide 100 replaces B76). In addition to granulations according to the FEPA standard, the comparative table below also states values according to the US ASTM standard and grit size in mm.



## ABRASIVE GRAIN APPLICABILITY

ABRASIVE GRAIN	Type of grinding, work piece, condition of material		
	TYPE OF GRINDING	GROUND MATERIAL	MATERIAL GRINDING HARDNESS
Aluminium oxide, normal	Coarse grinding, surface grinding	Low-alloy steel, iron materials	Tensile strength between 300 and 500 N/mm <sup>2</sup>
Aluminium oxide, semi-pure	Surface grinding, cylindrical grinding, multipurpose	Alloy steel	Tensile strength approx. 500 N/mm <sup>2</sup>
Aluminium oxide, pure, white	Surface grinding, external and internal cylindrical grinding, profile grinding	Alloy steel and high-alloy steel	Hardness up to 62 HRc
Aluminium oxide, pure, pink	Tool grinding, saw blade and knife sharpening, profile grinding, gear grinding	Hardened steel, casting	Tensile strength over 500 N/mm <sup>2</sup>
Aluminium oxide, special	All types of grinding	Hardened steel, tool steel, high-speed steel	Hardness over 62 HRc
Aluminium oxide, vitrified GA	All types of grinding	Alloy steel, high-alloy steel, tool steel	Hardness between 58 and 65 HRc, universal applicability
Aluminium oxide special LA	Finishing Universal applicability	All types of steel, alloys	Hardness up to 65 HRc
Corundum zirconium (only resin bonded)	Universal applicability	Alloys, low-alloy steel, tool steel, gray alloy, nodular alloy	
Silicon carbide, green	All types of grinding	Tungsten carbides, gray alloy, non-ferrous metals, plastic materials, nitriding steel, acid resistant steel	
Silicon carbide, black	All types of grinding	Gray alloy, plastic materials, non-ferrous metals, ceramics, glass	
CBN	All types of grinding	Steel	Hardness over 50 HRc
Diamond	All types of grinding	Hard metal alloys, ceramics	

## HARDNESS

Hardness is the resistance with which the bond prevents break-out of abrasive grains from the bond matrix. Degrees of hardness are designated with letters of the Latin alphabet. Hardness depends on the type and amount of the binding agent, grinding wheel structure and method of grinding wheel production.

A general rule for determining abrasive hardness is that grinding of harder materials requires a softer grinding tools and vice versa.

It is also a rule that smaller contact surfaces between the workpiece and grinding tool require a slightly harder grinding tool and vice versa: larger contact surfaces require a slightly softer, more porous grinding tool.

It is possible to determine the approximate hardness of bonded conventional abrasives for general grinding of steels of specific hardness.

When selecting specification, the grinding tool hardness should be:

- reduced by one to two hardness degrees at high material removal rates or when workpiece overheating needs to be prevented.
- increased by one to two hardness degrees when longer grinding tool life is a priority.

In the case of thinner grinding wheels, finer grit of higher hardness should be selected.

# STRUCTURE

The structure of a grinding tool determines the ratio of tool volume to abrasive grit volume. A normal structure is designated with numbers from 1 to 9, while an artificially created porous structure is designated from 10 to 20. The following needs to be designated for structures 11 to 20:

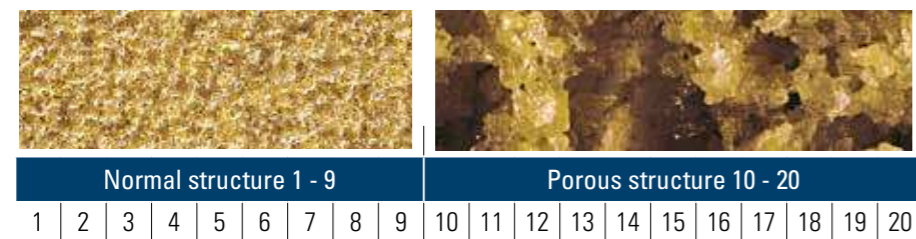

High-porosity grinding wheels provide the most favorable grinding procedure: self-sharpening, cold cutting, better chip removal, smaller force.

# GRINDING WHEEL BOND

The purpose of a bond is to bind abrasive grit and thus create the grinding wheel shape. The hardness, structure and grinding properties of grinding wheels depend on the type and amount of the bond.

**A vitrified bond** is a bond based on clay, kaolin and other materials/fillers. It is thermally treated at temperatures between 900 and 1300°C. In case of vitrified bonded grinding wheels, the range of hardness values is very broad.

The vitrified bond is sensitive to quick temperature changes and impacts, while various chemicals and duration of storage do not affect them. Normally, vitrified bonded grinding wheels are used at operating speeds of up to 40 m/s; they maintain their shape very well and can be used for all grinding applications (from very coarse grinding to the finest types of grinding).

**A resin bond** is an organic bond based on phenole formaldehyde resins and fillers. It is obtained by condensation of phenole and formaldehyde with an addition of hexa, and for some types also with a modifier

such as epoxy or caoutchouc. It gives the grinding wheel excellent mechanical properties and allows high peripheral speeds. It is also appropriate for reinforcement (using knitted glass fibres) in order to improve the mechanical properties of the grinding wheels. Compared to the vitrified bond, it is much less sensitive to quick temperature changes and impact, but more so to chemical influences and prolonged storage.

**Reinforced resin bond** is a variant of resin bond in which fibrous additives are used (usually glass fibres in the form of fabric). Since such bond is reinforced, the product's hardness increases considerably, so it can be used at higher peripheral speeds and side loads.

# SURFACE FINISH

Roughness of the ground surface in grinding with conventional grinding wheels with SiC and Al-oxide grain:

Roughness							Grit size								
Ra (µm)	CLA (µ")	Rt (µm)	Rz (µm)	French designation	Russian designation	Grade	36	46	60	80	120	180	320	500	
1,6	63			15		N7									Coarse grinding
1,5	60				Δ7										
1,25	50	10	6												
1	40														
0,80	32			14		N6									Medium fine grinding
0,63	25	5	3		Δ8										
0,50	20	4	2,5												
0,45	18	3,5	2,25												
0,40	16	3	2	13		N5									Medium fine grinding
0,35	14		1,36		Δ9										
0,32	12,5														
0,30	12	2,5	1,6												
0,25	10	2	1,2												Fine grinding
0,20	8	1,6	1	12		N4									
0,18	7,2				Δ10										
0,16	6,3	1,3	0,85												
0,14	5,6														
0,125	5	1,05	0,6												
0,10	4	0,9	0,5	11		N3									Fine grinding
0,09	3,6				Δ11										
0,08	3,2	0,8	0,4												
0,063	2,5	0,63	0,32												
0,06	2,4	0,6	0,3												
0,05	2	0,5	0,25	10		N2									Polishing
0,04	1,6	0,4	0,20		Δ12										
0,032	1,25														
0,03	1,2	0,3	0,15												
0,025	1	0,25	0,12	9		N1									Polishing
0,02	0,8	0,2	0,1		Δ13										
0,016	0,63	0,16	0,08												
0,012	0,50	0,12	0,06												
0,01	0,40	0,1	0,05												



## DIAMOND DRESSING TOOLS

Constant cooling of the diamond tip is necessary during surface dressing and profiling in order to prevent changes of the diamond properties.

Once the sharp edges of the grinding wheel cutting surface are worn out (as indicated by an increase in the normal force  $F_n$ , and an inefficient and loud grinding wheel), they need to be restored, i.e. surface dressed.

Various surface dressing tools are used for dressing of grinding wheels:

### Manual surface dressing:

Depending on the required accuracy, surface dressing may be performed with:

- vitrified bonded dressing tools,
- little metal wheels,
- single grit diamond dressing tools,
- multigrit diamond dressing tools.



### Machine surface dressing:

Single point dressing tools (with bases of different shapes),

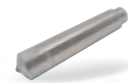

Dressing plates (attached to holders of different shapes),



Multipoint dressing tools (with bases of different shapes),



Diamond rolls (attached to holders of different shapes)



When a grinding wheel is mounted onto the machine spindle, it needs to be dressed for as long as it takes to level the entire grinding surface. If surface dressing is done during grinding, correct selection of the dressing parameters is important.

Dressing depth depends on the grit size in the grinding wheel, and is the same for all types of dressing tools.

Grit size according to FEPA	Dressing depth a (mm)
46	0,35
60	0,30
80	0,25
120	0,10
150	0,08
220	0,06
320	0,03
400	0,02

The other parameters are determined with respect to the dressing tool type.

## PROFILING OF GRINDING TOOLS

### Single point diamond dressing (profiling) tools:

These are used for profiling vitrified bonded grinding wheels and are named according to the profiling device or machine.

### Flat diamond dressing tools-Dialettes:

These are classified according to the shape and quality of the integrated diamond grit.

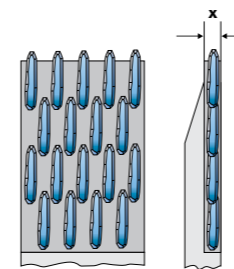

Dialette with pins

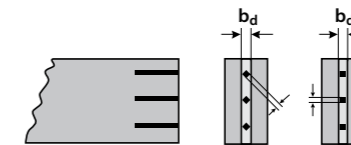

Dialette with MCD (monocrystalline diamond) pins:

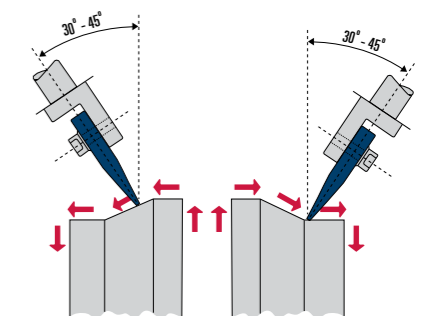
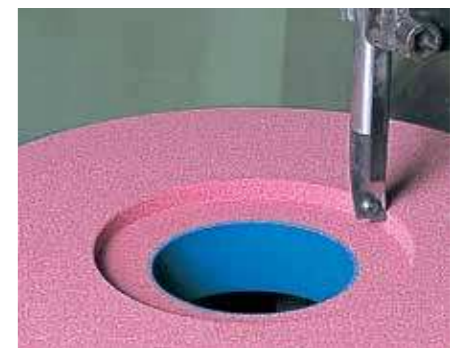

Dialette position in relation to the grinding wheel during dressing.

### Rotating diamond dressing tools:

Depending on the dressing method, rotating diamond dressing tools are produced:

- with the entire profile shape (without transverse motion):
- with the same profile as the model (with transverse motion):

Depending on the bond type, rotating dressing tools may be produced with:

- galvanic bond,
- metal bond.

When profiling is done using a template (programme), the dressing wheel's profile must be the same as that of the model. The dressing tool moves along a template, creating the same profile along the grinding wheel circumference.

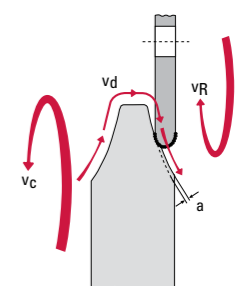
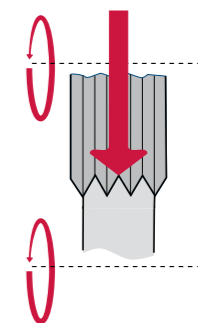

# SURFACE DRESSING

## WITH SINGLE POINT DIAMOND DRESSING TOOLS

Selection of diamond grit size:

The grit size of a single grit surface dressing tool depends on the grinding wheel size, and is determined using an equation or a diagram.

$$C_t = \frac{D + 2W}{400}$$

- $C_t$  - diamond grit size
- $D$  - grinding wheel diameter
- $W$  - grinding wheel width
- 400 - constant

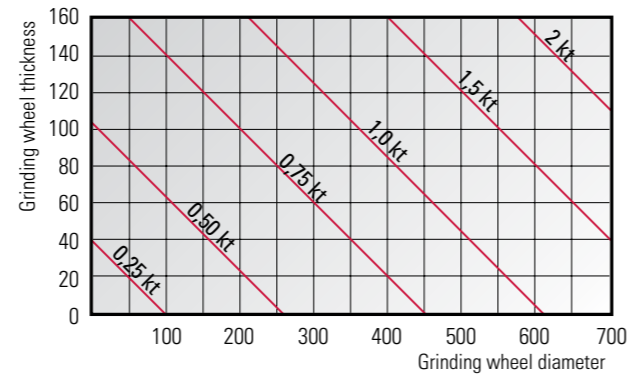

Depending on the shape, diamond grits for dressing tools are classified into three basic types.

No. of tips	Quality class
1	NORMAL
1 to 2	STANDARD
2 to 3	EXTRA

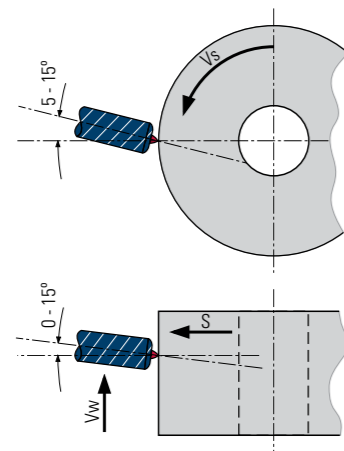

$$b = \max(2 \cdot a)$$

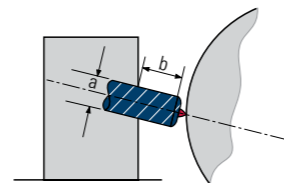

Dressing tool's transverse stroke:

Transverse stroke during dressing (mm/min) with single grit surface dressing tools depends on the type of grinding and the external grinding wheel diameter. The recommendations are as follows:

Type of grinding	Operating speed of 35 m/s					Operating speed of 50 m/s				
	Grinding wheel diameter (mm)									
	Ø200	Ø300	Ø400	Ø500	Ø600	Ø200	Ø300	Ø400	Ø500	Ø600
Coarse grinding	780	520	400	300	260	1000	730	560	420	360
Normal grinding	380	260	200	150	130	530	360	280	210	180
Fine grinding	280	150	120	100	80	390	210	170	140	110

### Restoration of single grit diamond dressing tools

Once the surface dressing tip has become worn out (i.e. when the contact surface area exceeds 1mm<sup>2</sup>), the dressing tool needs to be restored. Restoration turns the grit around or grinds it and turns it around.



New dressing tool



Worn out dressing tool



Useless dressing tool

## WITH MULTIPOINT DIAMOND DRESSING TOOLS

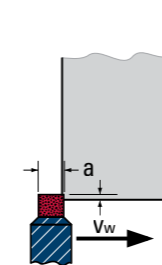

Multipoint dressing tools

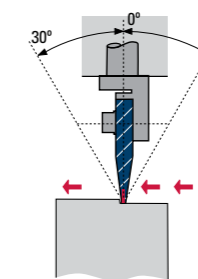

Dialettes

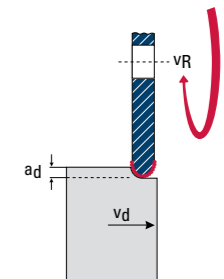

Diamond rolls



# COOLANTS

The purpose of a coolant is to cool the workpiece and grinding wheel during machining and to lubricate the ground surface. Cooling of the workpiece and tool is necessary to eliminate the unwanted effects of heat on both the workpiece and tool.

Lubrication is needed to reduce friction between the tool and workpiece and protect the workpiece from corrosion.



## Types of coolants

The following materials are used as coolants:

- oil for machining where very smooth surface is required,
- mineral, white emulsion - emulsion of oil in water with added emulsifiers and antibacterial additives; universally applicable,
- synthetic, clear emulsion - emulsion of synthetic oils in water; resistant to bacteria,
- synthetic coolants.

The coolant type and concentration depend on the machining method and type of material worked. It is recommended that the user consult the producer of coolant regarding the type of coolant and its concentration.

## Most important properties of coolants:

- good cooling and lubrication,
- prevention of corrosion,
- physical, chemical and technological stability during use,
- no harmful effects on human health,
- no excessive foaming.

## Cooling during machining

A sufficient amount of a coolant needs to be supplied at a certain pressure to the worked area during machining in order to perform this function. If the coolant is not supplied to the right place, its effects are suboptimal. The figures show the points/places to which the coolant needs to be supplied for individual types of grinding.

Reducing the amount of a coolant because it is sprayed around the work area may cause defects on the workpiece (cracks, thermal changes and similar problems).

During work and after it, the grinding wheel should not remain immersed in the coolant, because it might break during next use due to imbalance. When work is completed, the grinding wheel should be centrifuged to prevent damage upon reuse. Newer machines are constructed in such a way that the machining zone and thus also the cooling zone are enclosed and the coolant cannot be sprayed around.

## Surface grinding



## External grinding

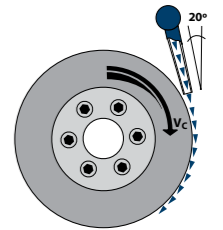

## Internal grinding

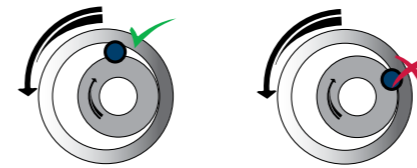

## Cooling during surface dressing

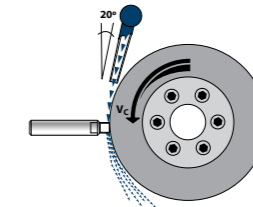

## Coolant maintenance

During surface dressing, cooling is necessary to lead heat away from the machining zone or to maintain the diamond's temperature stability. If the temperature in the dressing zone exceeds 620° C, a layer of graphite begins to be formed on the diamond surface, but if the temperature increases to 1200° C, all of the diamond grit will be transformed to graphite. If a coolant is not supplied during surface dressing or profiling in order to cool the surfaces and wash away the chips, some chips may be pressed into the grinding wheel surface, changing the grinding wheel shape.

Coolants need to be cleaned before they are supplied to the cutting site, so that the chips would not cause damage to the ground surface. A coolant cleaning device is usually positioned between the work area and the coolant tank, so that the coolant can be purified prior to its repeat use. The most common used cleaning devices are:

- magnetic coolant cleaner,
- paper cleaner,
- centrifugal cleaner,
- magnetic-paper cleaner.

The concentration and the pH value of the coolant should also be monitored regularly, because they might change due to high temperatures (water evaporation).

# SELECTION OF GRINDING WHEEL TYPE, DIMENSIONS AND SPECIFICATION

Selection of the shape and dimensions of grinding wheels is limited by the machine (the machine manufacturer prescribes/recommends the shapes and maximum dimensions of grinding wheels which can be used on the machine). When one has a choice, the highest permissible peripheral speed of the grinding wheel should be used as a guidance as prescribed by the manufacturer, along with the machine rpm setting options and the grinding method. The grinding wheel quality required for individual grinding methods should be selected as shown below.

There are a few general principles which apply to the selection of grinding wheel quality:

### Selection of abrasive grain type:

In selecting abrasive grit, the workpiece material and its condition should be taken into account. The general rule is that corundums should be used for grinding of steel materials, while for non-steel materials silicon carbides are considered to be the most appropriate.

### Selection of abrasive grain size:

In selecting abrasive grit size, the surface quality expected after grinding should be known. The abrasive grit size should be selected from the table or diagram based on the required roughness of the ground surface.

### Selection of grinding wheel hardness and structure:

In order to be able to select the correct grinding wheel hardness and structure, the condition of the ground material needs to be known (primarily its quality, hardness and any surface treatment/machining). When hardness is selected, it is important to select a softer grinding wheel for grinding harder materials and vice versa, i.e. a harder grinding wheel for grinding softer materials. There are certain principles which apply to grinding wheel hardness and structure, namely that it is impossible to manufacture low-hardness grinding wheels with a very closed structure and vice versa. When determining the grinding wheel hardness and structure, the use of a coolant is also relevant, i.e. with cooling, harder grinding wheels can be used than without it.

### Bond selection:

Grinding wheels of various bonds are available for grinding. Recommendations for selecting vitrified bonded grinding wheels are given below.

### The most common mistakes related to incorrect grinding wheel specification or inadequate machine settings:

If grinding does not yield satisfactory results, this means that you have selected an inappropriate grinding wheel quality or that there are some errors on the machine.

Appropriate grinding tool specification for each grinding application and for machining of standard materials are recommended below. The recommended specification are stated for general applications only. In the case of special grinding cases and for grinding of special materials, the user is advised to consult with the professional staff of the grinding tool manufacturer.

PROBLEMS	REASONS	SOLUTIONS
The ground surface becomes excessively overheated.	The selected grinding wheel is too hard. The grinding wheel is poorly balanced; the spindle bearings have play in them.	Reduce grinding wheel hardness. Produce a more open grinding wheel; reduce the working pressure and the grinding wheel's peripheral speed.
There may be vibrations on the machine.	The selected grinding wheel is too hard. The grinding wheel is poorly balanced; the spindle bearings have play in them.	Select a softer and more open grinding wheel. Check the grinding wheel's balance; fix machine settings.
The grinding wheel wears out very quickly.	The selected grinding wheel is too soft; grinding is done with excessive work pressure.	Select a harder and less porous grinding wheel. Reduce the working pressure and increase the grinding wheel's peripheral speed.
The grinding wheel's cutting edge does not maintain its shape.	The selected grinding wheel is too soft; the grit is too coarse.	Select a harder and less porous grinding wheel; select finer grit.
The material removal rate is too low.	To fine gritsize.	Select a coarser and softer grinding wheel; reduce grinding depth.
The grinding wheel's working surface becomes clogged too soon.	The selected grinding wheel is too fine; it is also too hard and too closed.	Select a coarser grinding wheel; select a softer and more open grinding wheel.
The ground surface is too rough.	The selected grinding wheel is too coarse.	Select a finer grinding wheel. Work with smaller moves and cutting depths; achieve a smoother surface by applying several grinding strokes.



# ORDERING

When ordering grinding tools, please state all the necessary parameters in your order: tool type, dimensions and specification. For repeat orders, grinding tool identification number will suffice. The grinding wheel specification is determined as follows:

- If you are already using the grinding tool, order an identical one (all data required for the order can be found on the cardboard flange or adhesive label on the product). If your grinding tool is not manufactured by WEILER ABRASIVES, please add the manufacturer's name in your order (in addition to the prescribed data).
- If you have no information on the grinding tool specification or are just beginning to grind, state all data on the machine, grinding method, ground material and required ground surface roughness in your order, or consult our technicians (fill out the TECHNICAL ORDER FORM).

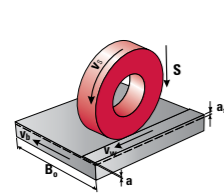

Surface grinding

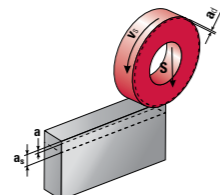

Surface grinding without transverse motion

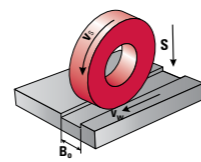

Profile grinding

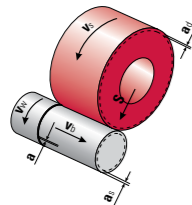

External cylindrical grinding

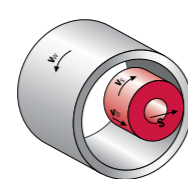

Internal cylindrical grinding

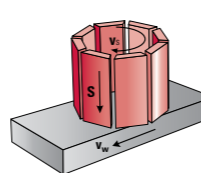

Surface grinding with segments

- $v_s$  - peripheral speed
- $v_w$  - speed of workpiece motion
- $v_b$  - transverse workpiece speed

- $s$  - tool transverse feed rate
- $a$  - grinding depth per turn
- $a_s$  - total grinding depth
- $B_o$  - ground surface width

- $G$  - volume grinding factor
- $V_w$  - volume of removed material
- $V_s$  - amount of wear on wheel

$$G = V_w / V_s$$

## TECHNICAL ORDER FORM

Customer: \_\_\_\_\_  
 Address: \_\_\_\_\_  
 Contact person: \_\_\_\_\_  
 Phone: \_\_\_\_\_  
 e-mail: \_\_\_\_\_

### WORKPIECE INFORMATION

Workpiece description (shape, dimensions etc.): \_\_\_\_\_  
 Workpiece material and grade: \_\_\_\_\_  
 Workpiece hardness (HV, HB, HRC): \_\_\_\_\_  
 Required surface finish (N,Ra,Rt,Rz): \_\_\_\_\_

GRINDING METHOD: other methods: \_\_\_\_\_

Grinding machine /type: \_\_\_\_\_  
 Grinding wheel peripheral speed (m/s or RPM): \_\_\_\_\_  
 Workpiece speed (RPM): \_\_\_\_\_  
 Infeed (mm): \_\_\_\_\_  
 Transverse speed (m/min): \_\_\_\_\_  
 Grinding allowance (mm): \_\_\_\_\_  
 Grinding time (sec): \_\_\_\_\_  
 Other process parameters: \_\_\_\_\_  
 Cooling:  YES  NO Coolant type (designation): \_\_\_\_\_  
 Flow rate (l/min): \_\_\_\_\_  
 Pressure (bar): \_\_\_\_\_

### DRESSING PARAMETERS

Dresser type: \_\_\_\_\_  
 Dressing Infeed (mm): \_\_\_\_\_  
 Dressing frequency: \_\_\_\_\_  
 Dressing Trav. Speed (mm/min) \_\_\_\_\_

### COMPARISON WITH SIMILAR GRINDING WHEELS FROM OTHER MANUFACTURERS

Manufacturer: \_\_\_\_\_  
 Wheel type and dimensions: \_\_\_\_\_  
 Wheel designation: \_\_\_\_\_  
 Notes: \_\_\_\_\_





# THE WEILER PROMISE

At Weiler, we passionately embrace change to improve our products and our processes to move the company and our customers forward. By bringing new ideas and creative problem solving together in an open, collaborative environment, we will improve our customers' productivity and create profitable growth.

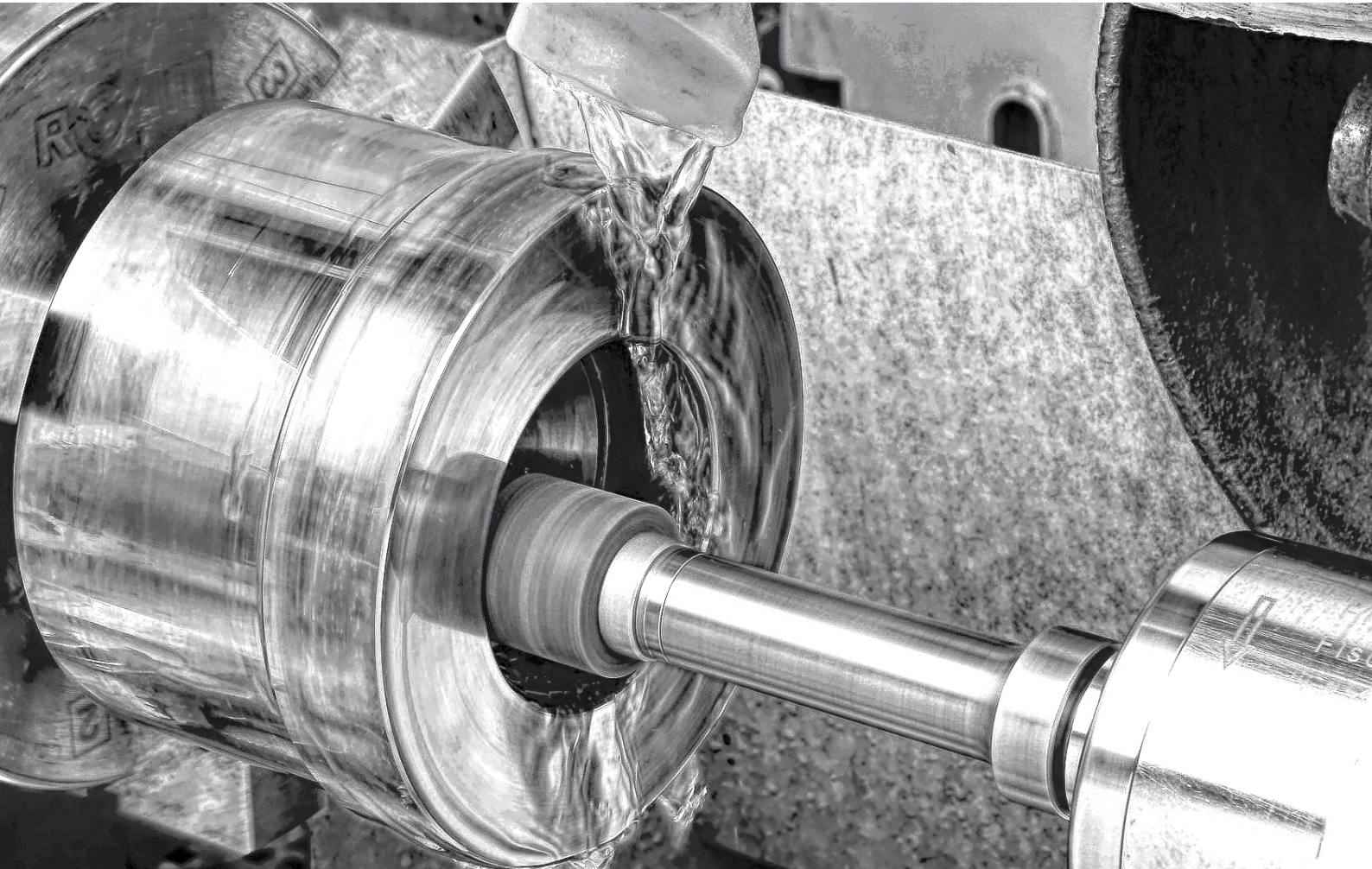

## WEILER ABRASIVES GROUP

**Weiler Abrasives**  
**One Weiler Drive**  
**Cresco, PA 18326 USA**

Weiler de México  
Querétaro, México

Weiler do Brasil  
Vinhedo, Brasil

Weiler Abrasives  
Bindlach, Germany

Weiler Abrasives  
Slovenia  
• Maribor  
• Zreče  
• Loče